















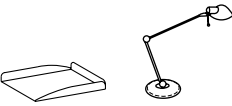

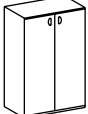

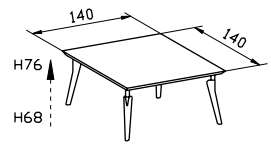
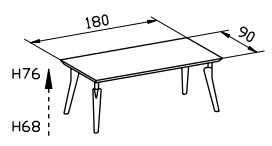
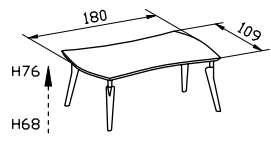
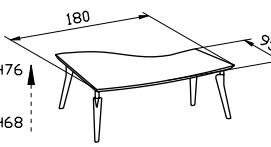
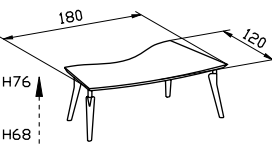
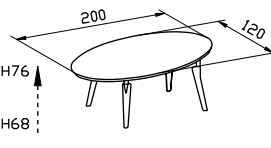
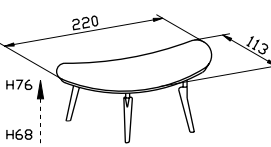
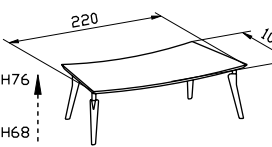
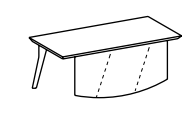
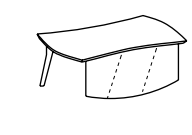
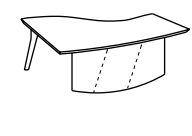
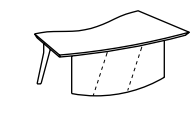
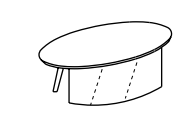
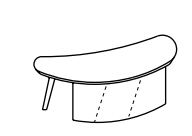
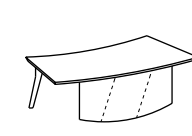

# MASTER POINT

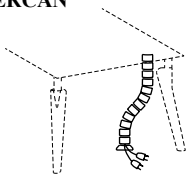
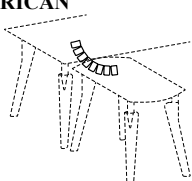
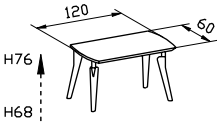
|   |       |         |
|---|-------|---------|
|    | ----- | Pag. 6  |
|    | ----- | Pag. 7  |
|    | ----- | Pag. 8  |
|    | ----- | Pag. 8  |
|   | ----- | Pag. 9  |
|  | ----- | Pag. 10 |
|  | ----- | Pag. 11 |
|  | ----- | Pag. 12 |
|  | ----- | Pag. 15 |
|  | ----- | Pag. 19 |
|  | ----- | Pag. 23 |
|  | ----- | Pag. 27 |
| CARATTERISTICHE TECNICHE - TECHNICAL SPECIFICATIONS - FICHE TECHNIQUE               |       | Pag. 29 |

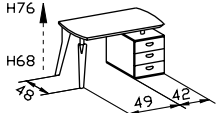
SCRIVANIE CON PIANO IN LEGNO  
 WRITING DESKS WITH WOODEN TOP  
 BUREAUX AVEC DESSUS EN BOIS  
 ESCRITORIOS CON TAPA EN MADERA

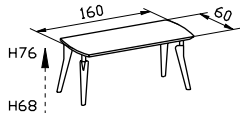
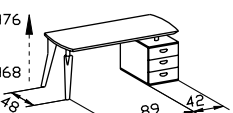
|   |  |  |  |
|---|--|--|--|
| <p><b>MCN / 140RA</b><br/> <b>MCY</b><br/> <b>MQN</b><br/> <b>MQY</b></p>    | <p>SCRIVANIA REGISTRABILE<br/>                 ADJUSTABLE WRITING DESK<br/>                 BUREAU RÉGLABLE<br/>                 ESCRITORIO AJUSTABLE</p> <p>N.2 MN-MY/R2G+MC-MQ /14APS</p>  | <p><b>MCN / 180R</b><br/> <b>MCY</b><br/> <b>MQN</b><br/> <b>MQY</b></p>     | <p>SCRIVANIA REGISTRABILE<br/>                 ADJUSTABLE WRITING DESK<br/>                 BUREAU RÉGLABLE<br/>                 ESCRITORIO AJUSTABLE</p> <p>N.2 MN-MY/R2G+MC-MQ /18PS</p>   |
| <p>Cm 140x140x68-76 h - Mc 0,341 - Kgl 64,4 - N°3</p>   | <p><b>€ 2.202,00</b></p>   | <p>Cm 180x90x68-76 h - Mc 0,303 - Kgl 57,4 - N°3</p>   | <p><b>€ 1.711,00</b></p>   |
| <p><b>MCN / 180RF</b><br/> <b>MCY</b></p>                                    | <p>SCRIVANIA SAGOMATA REGISTRABILE<br/>                 ADJUSTABLE SHAPED WRITING DESK<br/>                 BUREAU RÉGLABLE FAÇONNÉ<br/>                 ESCRITORIO AJUSTABLE CURVADO</p> <p>N.2 MN-MY/R2G+MC/18FPS</p>  |  |  |
| <p>Cm 180x109x68-76 h - Mc 0,340 - Kgl 65,5 - N°3</p>   | <p><b>€ 1.898,00</b></p>   |  |  |
| <p><b>MCN / 180RZD</b><br/> <b>MCY</b></p>                                   | <p>SCRIVANIA SAGOMATA REGISTRABILE<br/>                 ADJUSTABLE SHAPED WRITING DESK<br/>                 BUREAU RÉGLABLE FAÇONNÉ<br/>                 ESCRITORIO AJUSTABLE CURVADO</p> <p>N.2 MN-MY/R2G+MC/18ZDPS</p>   | <p><b>MCN / 180RZS</b><br/> <b>MCY</b></p>                                   | <p>SCRIVANIA SAGOMATA REGISTRABILE<br/>                 ADJUSTABLE SHAPED WRITING DESK<br/>                 BUREAU RÉGLABLE FAÇONNÉ<br/>                 ESCRITORIO AJUSTABLE CURVADO</p> <p>N.2 MN-MY/R2G+MC/18ZSPS</p>   |
| <p>Cm 180x120x68-76 h - Mc 0,365 - Kgl 62,7 - N°3</p>   | <p><b>€ 1.962,00</b></p>   | <p>Cm 180x120x68-76 h - Mc 0,365 - Kgl 62,7 - N°3</p>  | <p><b>€ 1.962,00</b></p>   |
| <p><b>MCN / 200RB</b><br/> <b>MCY</b><br/> <b>MQN</b><br/> <b>MQY</b></p>    | <p>SCRIVANIA SAGOMATA REGISTRABILE<br/>                 ADJUSTABLE SHAPED WRITING DESK<br/>                 BUREAU RÉGLABLE FAÇONNÉ<br/>                 ESCRITORIO AJUSTABLE CURVADO</p> <p>N.2 MN-MY/R2G+MC-MQ/20BPS</p>   |  |  |
| <p>Cm 200x120x68-76 h - Mc 0,303 - Kgl 57,4 - N°3</p>   | <p><b>€ 2.049,00</b></p>   |  |  |
| <p><b>MCN / 220RC</b><br/> <b>MCY</b><br/> <b>MQN</b><br/> <b>MQY</b></p>  | <p>SCRIVANIA SAGOMATA REGISTRABILE<br/>                 ADJUSTABLE SHAPED WRITING DESK<br/>                 BUREAU RÉGLABLE FAÇONNÉ<br/>                 ESCRITORIO AJUSTABLE CURVADO</p> <p>N.2 MN-MY/R2G+MC-MQ/22CPS</p>   | <p><b>MCN / 220RD</b><br/> <b>MCY</b><br/> <b>MQN</b><br/> <b>MQY</b></p>  | <p>SCRIVANIA SAGOMATA REGISTRABILE<br/>                 ADJUSTABLE SHAPED WRITING DESK<br/>                 BUREAU RÉGLABLE FAÇONNÉ<br/>                 ESCRITORIO AJUSTABLE CURVADO</p> <p>N.2 MN-MY/R2G+MC-MQ/22DPS</p>   |
| <p>Cm 220x113x68-76 h - Mc 0,392 - Kgl 65,4 - N°3</p>   | <p><b>€ 2.100,00</b></p>   | <p>Cm 220x104x68-76 h - Mc 0,402 - Kgl 66,4 - N°3</p>  | <p><b>€ 2.006,00</b></p>   |
| <p><b>MCN / 180C</b><br/> <b>MCY</b><br/> <b>MQN</b><br/> <b>MQY</b></p>   | <p>SCRIVANIA CON SCHIENALE RIVESTITO IN CUIO<br/>                 WRITING DESK WITH LEATHER COVERED BACK<br/>                 BUREAU AVEC DOSSIER REVÊTU EN CUIR<br/>                 ESCRITORIO CON TRASERA REVESTIDA DE CUERO</p> <p>MN-MY/R2G+MM/STAF+MN-MY/FRC+<br/>                 MC-MQ /18PS</p> | <p><b>MCN / 180FC</b><br/> <b>MCY</b></p>                                  | <p>SCRIVANIA CON SCHIENALE RIVESTITO IN CUIO<br/>                 WRITING DESK WITH LEATHER COVERED BACK<br/>                 BUREAU AVEC DOSSIER REVÊTU EN CUIR<br/>                 ESCRITORIO CON TRASERA REVESTIDA DE CUERO</p> <p>MN-MY/R2G+MM/STAF+MN-MY/FRC+MC/18FPS</p>                          |
| <p>Cm 180x90x72 h - Mc 0,493 - Kgl 72,7 - N°4</p>   | <p><b>€ 2.306,00</b></p>   | <p>Cm 180x109x72 h - Mc 0,530 - Kgl 80,8 - N°4</p>   | <p><b>€ 2.492,00</b></p>   |
| <p><b>MCN / 180ZDC</b><br/> <b>MCY</b></p>                                 | <p>SCRIVANIA CON SCHIENALE RIVESTITO IN CUIO<br/>                 WRITING DESK WITH LEATHER COVERED BACK<br/>                 BUREAU AVEC DOSSIER REVÊTU EN CUIR<br/>                 ESCRITORIO CON TRASERA REVESTIDA DE CUERO</p> <p>MN-MY/R2G+MM/STAF+MN-MY/FRC+MC/18ZDPS</p>                         | <p><b>MCN / 180ZSC</b><br/> <b>MCY</b></p>                                 | <p>SCRIVANIA CON SCHIENALE RIVESTITO IN CUIO<br/>                 WRITING DESK WITH LEATHER COVERED BACK<br/>                 BUREAU AVEC DOSSIER REVÊTU EN CUIR<br/>                 ESCRITORIO CON TRASERA REVESTIDA DE CUERO</p> <p>MN-MY/R2G+MM/STAF+MN-MY/FRC+MC/18ZSPS</p>                         |
| <p>Cm 180x120x72 h - Mc 0,555 - Kgl 78,0 - N°4</p>  | <p><b>€ 2.557,00</b></p>   | <p>Cm 180x120x72 h - Mc 0,555 - Kgl 78,0 - N°4</p>   | <p><b>€ 2.557,00</b></p>   |
| <p><b>MCN / 200BC</b><br/> <b>MCY</b><br/> <b>MQN</b><br/> <b>MQY</b></p>  | <p>SCRIVANIA CON SCHIENALE RIVESTITO IN CUIO<br/>                 WRITING DESK WITH LEATHER COVERED BACK<br/>                 BUREAU AVEC DOSSIER REVÊTU EN CUIR<br/>                 ESCRITORIO CON TRASERA REVESTIDA DE CUERO</p> <p>MN-MY/R2G+MM/STAF+MN-MY/FRC+<br/>                 MC-MQ/20BPS</p> |  |  |
| <p>Cm 200x120x72 h - Mc 0,582 - Kgl 80,7 - N°4</p>  | <p><b>€ 2.644,00</b></p>   |  |  |
| <p><b>MCN / 220CC</b><br/> <b>MCY</b><br/> <b>MQN</b><br/> <b>MQY</b></p>  | <p>SCRIVANIA CON SCHIENALE RIVESTITO IN CUIO<br/>                 WRITING DESK WITH LEATHER COVERED BACK<br/>                 BUREAU AVEC DOSSIER REVÊTU EN CUIR<br/>                 ESCRITORIO CON TRASERA REVESTIDA DE CUERO</p> <p>MN-MY/R2G+MM/STAF+MN-MY/FRC+<br/>                 MC-MQ/22CPS</p> | <p><b>MCN / 220DC</b><br/> <b>MCY</b><br/> <b>MQN</b><br/> <b>MQY</b></p>  | <p>SCRIVANIA CON SCHIENALE RIVESTITO IN CUIO<br/>                 WRITING DESK WITH LEATHER COVERED BACK<br/>                 BUREAU AVEC DOSSIER REVÊTU EN CUIR<br/>                 ESCRITORIO CON TRASERA REVESTIDA DE CUERO</p> <p>MN-MY/R2G+MM/STAF+MN-MY/FRC+<br/>                 MC-MQ/22DPS</p> |
| <p>Cm 220x113x72 h - Mc 0,592 - Kgl 81,7 - N°4</p>  | <p><b>€ 2.695,00</b></p>   | <p>Cm 220x104x72 h - Mc 0,570 - Kgl 82,7 - N°4</p>   | <p><b>€ 2.600,00</b></p>   |

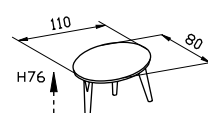

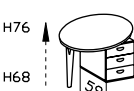
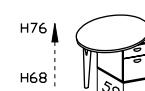
|   |  |  |   |                   |
|---|--|--|---|-------------------|
| CANALLETTE PORTA CAVI<br>CABLES CONDUIT<br>GAINES POUR CÂBLES<br>CANALES PASACABLES   | <b>MM / V20CAN</b><br><br>CANALETTA PORTACAVI PER SCRIVANIA PIANO VETRO:<br>CABLE CONDUIT FOR WRITING DESK WITH GLASS TOP:<br>GAINES PASSE-CÂBLES POUR BUREAU DESSUS EN VERRE:<br>CANAL PASACABLES PARA ESCRITORIO TAPA DE VIDRIO:<br>MCV-MFV/200BC-220DC<br>MM/V20CAN          | <b>MM / V22CAN</b><br><br>CANALETTA PORTACAVI PER SCRIVANIA PIANO VETRO:<br>CABLE CONDUIT FOR WRITING DESK WITH GLASS TOP:<br>GAINES PASSE-CÂBLES POUR BUREAU DESSUS EN VERRE:<br>CANAL PASACABLES PARA ESCRITORIO TAPA DE VIDRIO:<br>MCV-MFV/220CC<br>MM/V22CAN               |   |                   |
|   | Cm 92x12x7 h - Mc 0,010 - Kgl 2,1 - N°1  | <b>€ 79,00</b>   | Cm 114x12x7 h - Mc 0,010 - Kgl 2,2 - N°1      | <b>€ 82,00</b>    |
|   | <b>NM / VERCAN</b><br><br>PASSACAVI VERTICALE SOTTO PIANO SCRIVANIA<br>VERTICAL CABLE CONDUIT UNDER THE DESKTOP<br>PASSE-CÂBLES VERTICAL SOUS LE PLATEAU<br>PASACABLES VERTICAL DEBAJO TAPA ESCRITORIO<br>NM/VERCAN   | <b>NM / ORICAN</b><br><br>PASSACAVI ORIZZONTALE TRA DUE SCRIVANIE<br>HORIZONTAL CABLE CONDUIT BETWEEN 2 WRITING DESKS<br>PASSE-CÂBLES HORIZONTAL ENTRE 2 BUREAUX<br>PASACABLES HORIZONTAL ENTRE 2 ESCRITORIOS<br>NM/ORICAN   |   |                   |
|   | Cm ø10x78 h - Mc 0,005 - Kgl 0,7 - N°1   | <b>€ 66,00</b>   | Cm ø10x90 h - Mc 0,005 - Kgl 0,6 - N°1        | <b>€ 69,00</b>    |
| ALLUNGI CON PIANO IN LEGNO<br>EXTENSIONS WITH WOODEN TOP<br>RALLONGES AVEC DESSUS EN BOIS<br>EXTENSIONES CON TAPA EN MADERA   | <b>MCN / RAL</b><br><b>MCY</b><br><b>MQN</b><br><b>MQY</b><br><br>ALLUNGO SAGOMATO REGISTRABILE<br>ADJUSTABLE SHAPED EXTENSION<br>RALLONGE RÉGLABLE FAÇONNÉ<br>EXTENSION CURVADA AJUSTABLE<br>N.2 MN-MY/R2G+MC-MQ/ALPS  | <b>MCN / RALN</b><br><b>MCY</b><br><b>MQN</b><br><b>MQY</b><br><br>ALLUNGO REGISTRABILE CON RUOTE<br>ADJUSTABLE EXTENSION ON CASTORS<br>RALLONGE RÉGLABLE SUR ROULETTES<br>EXTENSION AJUSTABLE CON RUEDAS<br>MN-MY/R2G+MN-MY/R2GN+<br>MC-MQ/ALPS                               |   |                   |
|   | Cm 120x60x68-76 h - Mc 0,164 - Kgl 33,4 - N°3  | <b>€ 1.395,00</b>  | Cm 120x60x68-76 h - Mc 0,164 - Kgl 33,6 - N°3 | <b>€ 1.478,00</b> |
|   | <b>MCN / RAL31</b><br><b>MCY</b><br><b>MQN</b><br><b>MQY</b><br><br>ALLUNGO REGISTRABILE CON CASSETTIERA<br>ADJUSTABLE EXTENSION WITH DRAWER BOX<br>RALLONGE RÉGLABLE AVEC CAISSON<br>EXTENSION AJUSTABLE CON CAJONERA<br>MN-MY/R2G+<br>MCN-MCY-MQN-MQY/R31RE+<br>MC-MQ/ALPS  | <b>MCN / RAL33</b><br><b>MCY</b><br><b>MQN</b><br><b>MQY</b><br><br>ALLUNGO REGISTRABILE CON CASSETTIERA<br>ADJUSTABLE EXTENSION WITH DRAWER BOX<br>RALLONGE RÉGLABLE AVEC CAISSON<br>EXTENSION AJUSTABLE CON CAJONERA<br>MN-MY/R2G+<br>MCN-MCY-MQN-MQY/R33RE+<br>MC-MQ/ALPS |   |                   |
|   | Cm 120x60x68-76 h - Mc 0,322 - Kgl 61,9 - N°3  | <b>€ 2.306,00</b>  | Cm 120x60x68-76 h - Mc 0,322 - Kgl 59,4 - N°3 | <b>€ 2.248,00</b> |
|   | <b>MCN / RAB</b><br><b>MCY</b><br><br>ALLUNGO SAGOMATO REGISTRABILE<br>ADJUSTABLE SHAPED EXTENSION<br>RALLONGE RÉGLABLE FAÇONNÉ<br>EXTENSION CURVADA AJUSTABLE<br>N.2 MN-MY/R2G+MC/ABPS   |  |   |                   |
|   | Cm 160x60x68-76 h - Mc 0,182 - Kgl 39,1 - N°3  | <b>€ 1.772,00</b>  |   |                   |
|   | <b>MCN / RAB31</b><br><b>MCY</b><br><br>ALLUNGO REGISTRABILE CON CASSETTIERA<br>ADJUSTABLE EXTENSION WITH DRAWER BOX<br>RALLONGE RÉGLABLE AVEC CAISSON<br>EXTENSION AJUSTABLE CON CAJONERA<br>MN-MY/R2G+MCN-MCY/R31RE+<br>MC/ABPS   | <b>MCN / RAB33</b><br><b>MCY</b><br><br>ALLUNGO REGISTRABILE CON CASSETTIERA<br>ADJUSTABLE EXTENSION WITH DRAWER BOX<br>RALLONGE RÉGLABLE AVEC CAISSON<br>EXTENSION AJUSTABLE CON CAJONERA<br>MN-MY/R2G+MCN-MCY/R33RE+<br>MC/ABPS  |   |                   |
|   | Cm 160x60x68-76 h - Mc 0,340 - Kgl 65,9 - N°3  | <b>€ 2.683,00</b>  | Cm 160x60x68-76 h - Mc 0,340 - Kgl 63,4 - N°3 | <b>€ 2.626,00</b> |
|   | <b>MCN / RRE</b><br><b>MCY</b><br><b>MQN</b><br><b>MQY</b><br><br>ALLUNGO SAGOMATO REGISTRABILE<br>ADJUSTABLE SHAPED EXTENSION<br>RALLONGE RÉGLABLE FAÇONNÉ<br>EXTENSION CURVADA AJUSTABLE<br>MN-MY/R1G+MN-MY/R2G+MC-MQ/REPS  | <b>MCN / RREN</b><br><b>MCY</b><br><b>MQN</b><br><b>MQY</b><br><br>ALLUNGO REGISTRABILE CON RUOTE<br>ADJUSTABLE EXTENSION ON CASTORS<br>RALLONGE RÉGLABLE SUR ROULETTES<br>EXTENSION AJUSTABLE CON RUEDAS<br>MN-MY/R1G+MN-MY/R2GN+<br>MC-MQ/REPS                             |   |                   |
|   | Cm 110x80x68-76 h - Mc 0,175 - Kgl 29,2 - N°3  | <b>€ 1.255,00</b>  | Cm 110x80x68-76 h - Mc 0,175 - Kgl 29,4 - N°3 | <b>€ 1.337,00</b> |
| <b>MCN / RRE31</b><br><b>MCY</b><br><b>MQN</b><br><b>MQY</b><br><br>ALLUNGO REGISTRABILE CON CASSETTIERA<br>ADJUSTABLE EXTENSION WITH DRAWER BOX<br>RALLONGE RÉGLABLE AVEC CAISSON<br>EXTENSION AJUSTABLE CON CAJONERA<br>MN-MY/R1G+<br>MCN-MCY-MQN-MQY/R31RE+<br>MC-MQ/REPS | <b>MCN / RRE33</b><br><b>MCY</b><br><b>MQN</b><br><b>MQY</b><br><br>ALLUNGO REGISTRABILE CON CASSETTIERA<br>ADJUSTABLE EXTENSION WITH DRAWER BOX<br>RALLONGE RÉGLABLE AVEC CAISSON<br>EXTENSION AJUSTABLE CON CAJONERA<br>MN-MY/R1G+<br>MCN-MCY-MQN-MQY/R33RE+<br>MC-MQ/REPS |  |   |                   |
| Cm 110x80x68-76 h - Mc 0,333 - Kgl 61,9 - N°3   | <b>€ 2.165,00</b>  | Cm 110x80x68-76 h - Mc 0,333 - Kgl 59,4 - N°3  | <b>€ 2.107,00</b>                             |                   |

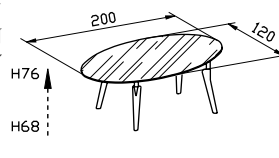
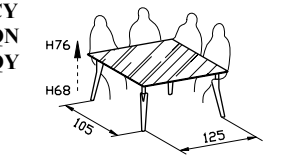
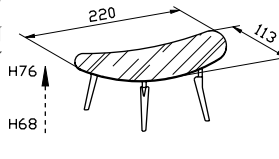
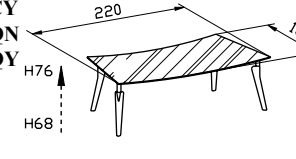
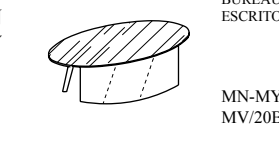
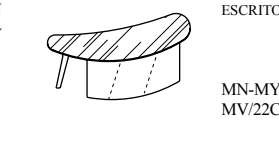
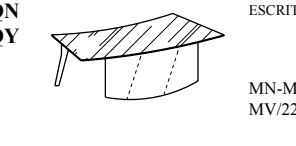
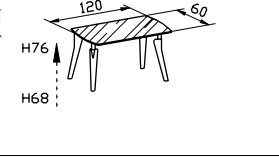
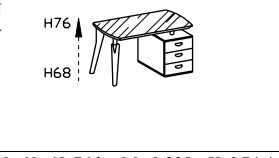
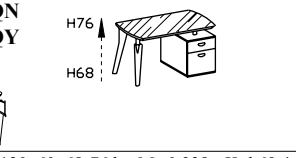
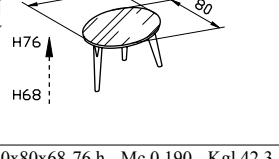
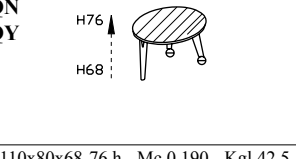
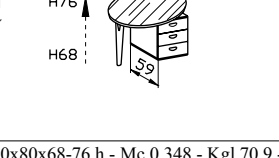
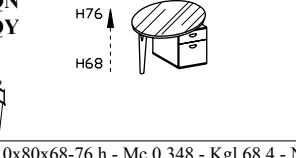

SCRIVANIE ED ALLUNGHI CON PIANO IN VETRO  
 WRITING DESKS AND EXTENSIONS WITH GLASS TOP  
 BUREAUX ET RALLONGES AVEC DESSUS EN VERRE  
 ESCRITORIOS Y EXTENSIONES CON TAPA DE VIDRIO

|   |   |  |  |
|---|---|--|--|
| <p><b>MCN / VT200RB</b><br/> <b>MCY</b><br/> <b>MQN</b><br/> <b>MQY</b></p>    | <p>SCRIVANIA SAGOMATA REGISTRABILE<br/>                 ADJUSTABLE SHAPED WRITING DESK<br/>                 BUREAU RÉGLABLE FAÇONNÉ<br/>                 ESCRITORIO AJUSTABLE CURVADO</p> <p>N.2 MN-MY/VTR2G+MV/20BPV</p>   | <p><b>MCN / VT140RTA</b><br/> <b>MCY</b><br/> <b>MQN</b><br/> <b>MQY</b></p>   | <p>TAVOLO RIUNIONE REGISTRABILE (8 POSTI)<br/>                 ADJUSTABLE MEETING TABLE (8 SEATS)<br/>                 TABLE DE RÉUNION RÉGLABLE (8 PLACES)<br/>                 MESA DE REUNIÓN AJUSTABLE (8 ASIENTOS)</p> <p>N.2 MN-MY/VTR2G+MV/14APV</p>                          |
| <p>Cm 200x120x68-76 h - Mc 0,461 - Kgl 112,8 - N°3</p>  | <p>€ 2.809,00</p>   | <p>Cm 140x120x68-76 h - Mc 0,358 - Kgl 107,1 - N°3</p>   | <p>€ 2.654,00</p>  |
| <p><b>MCN / VT220RC</b><br/> <b>MCY</b><br/> <b>MQN</b><br/> <b>MQY</b></p>    | <p>SCRIVANIA SAGOMATA REGISTRABILE<br/>                 ADJUSTABLE SHAPED WRITING DESK<br/>                 BUREAU RÉGLABLE FAÇONNÉ<br/>                 ESCRITORIO AJUSTABLE CURVADO</p> <p>N.2 MN-MY/VTR2G+MV/22CPV</p>   | <p><b>MCN / VT220RD</b><br/> <b>MCY</b><br/> <b>MQN</b><br/> <b>MQY</b></p>    | <p>SCRIVANIA SAGOMATA REGISTRABILE<br/>                 ADJUSTABLE SHAPED WRITING DESK<br/>                 BUREAU RÉGLABLE FAÇONNÉ<br/>                 ESCRITORIO AJUSTABLE CURVADO</p> <p>N.2 MN-MY/VTR2G+MV/22DPV</p>  |
| <p>Cm 220x113x68-76 h - Mc 0,471 - Kgl 114,8 - N°3</p>  | <p>€ 2.809,00</p>   | <p>Cm 220x104x68-76 h - Mc 0,447 - Kgl 117,3 - N°3</p>   | <p>€ 2.809,00</p>  |
| <p><b>MCN / VT200BC</b><br/> <b>MCY</b><br/> <b>MQN</b><br/> <b>MQY</b></p>    | <p>SCRIVANIA CON SCHIENALE RIVESTITO IN CUIO<br/>                 WRITING DESK WITH LEATHER COVERED BACK<br/>                 BUREAU AVEC DOSSIER REVÊTU EN CUIR<br/>                 ESCRITORIO CON TRASERA REVESTIDA DE CUERO</p> <p>MN-MY/VTR2G+MMV/STAFV+MN-MY/FRC+MV/20BPV</p> |  |  |
| <p>Cm 200x120x72 h - Mc 0,651 - Kgl 130,7 - N°4</p>   | <p>€ 3.459,00</p>   |  |  |
| <p><b>MCN / VT220CC</b><br/> <b>MCY</b><br/> <b>MQN</b><br/> <b>MQY</b></p>    | <p>SCRIVANIA CON SCHIENALE RIVESTITO IN CUIO<br/>                 WRITING DESK WITH LEATHER COVERED BACK<br/>                 BUREAU AVEC DOSSIER REVÊTU EN CUIR<br/>                 ESCRITORIO CON TRASERA REVESTIDA DE CUERO</p> <p>MN-MY/VTR2G+MMV/STAFV+MN-MY/FRC+MV/22CPV</p> | <p><b>MCN / VT220DC</b><br/> <b>MCY</b><br/> <b>MQN</b><br/> <b>MQY</b></p>    | <p>SCRIVANIA CON SCHIENALE RIVESTITO IN CUIO<br/>                 WRITING DESK WITH LEATHER COVERED BACK<br/>                 BUREAU AVEC DOSSIER REVÊTU EN CUIR<br/>                 ESCRITORIO CON TRASERA REVESTIDA DE CUERO</p> <p>MN-MY/VTR2G+MMV/STAFV+MN-MY/FRC+MV/22DCPV</p> |
| <p>Cm 220x113x72 h - Mc 0,661 - Kgl 132,7 - N°4</p>   | <p>€ 3.459,00</p>   | <p>Cm 220x104x72 h - Mc 0,637 - Kgl 135,2 - N°4</p>  | <p>€ 3.459,00</p>  |
| <p><b>MCN / VTRAL</b><br/> <b>MCY</b><br/> <b>MQN</b><br/> <b>MQY</b></p>    | <p>ALLUNGO SAGOMATO REGISTRABILE<br/>                 ADJUSTABLE SHAPED EXTENSION<br/>                 RALLONGE RÉGLABLE FAÇONNÉ<br/>                 EXTENSION CURVADA AJUSTABLE</p> <p>N.2 MN-MY/VTR2G+MV/ALPV</p>  |  |  |
| <p>Cm 120x60x68-76 h - Mc 0,180 - Kgl 45,8 - N°3</p>  | <p>€ 1.556,00</p>   |  |  |
| <p><b>MCN / VTRAL31</b><br/> <b>MCY</b><br/> <b>MQN</b><br/> <b>MQY</b></p>  | <p>ALLUNGO REGISTRABILE CON CASSETTIERA<br/>                 ADJUSTABLE EXTENSION WITH DRAWER BOX<br/>                 RALLONGE RÉGLABLE AVEC CAISSON<br/>                 EXTENSION AJUSTABLE CON CAJONERA</p> <p>MN-MY/VTR2G+MCN-MCY-MQN-MQY/VTR31RE+MV/ALPV</p>                  | <p><b>MCN / VTRAL33</b><br/> <b>MCY</b><br/> <b>MQN</b><br/> <b>MQY</b></p>  | <p>ALLUNGO REGISTRABILE CON CASSETTIERA<br/>                 ADJUSTABLE EXTENSION WITH DRAWER BOX<br/>                 RALLONGE RÉGLABLE AVEC CAISSON<br/>                 EXTENSION AJUSTABLE CON CAJONERA</p> <p>MN-MY/VTR2G+MCN-MCY-MQN-MQY/VTR33RE+MV/ALPV</p>                   |
| <p>Cm 120x60x68-76 h - Mc 0,338 - Kgl 74,4 - N°3</p>  | <p>€ 2.467,00</p>   | <p>Cm 120x60x68-76 h - Mc 0,338 - Kgl 69,4 - N°3</p>   | <p>€ 2.409,00</p>  |
| <p><b>MCN / VTRRE</b><br/> <b>MCY</b><br/> <b>MQN</b><br/> <b>MQY</b></p>    | <p>ALLUNGO SAGOMATO REGISTRABILE<br/>                 ADJUSTABLE SHAPED EXTENSION<br/>                 RALLONGE RÉGLABLE FAÇONNÉ<br/>                 EXTENSION CURVADA AJUSTABLE</p> <p>MN-MY/VTR1G+MN-MY/VTR2G+MV/REPV</p>  | <p><b>MCN / VTRREN</b><br/> <b>MCY</b><br/> <b>MQN</b><br/> <b>MQY</b></p>   | <p>ALLUNGO REGISTRABILE CON RUOTE<br/>                 ADJUSTABLE EXTENSION WITH CASTORS<br/>                 RALLONGE RÉGLABLE SUR ROULETTES<br/>                 EXTENSION AJUSTABLE CON RUEDAS</p> <p>MN-MY/VTR1G+MN-MY/VTR2GN+MV/REPV</p>  |
| <p>Cm 110x80x68-76 h - Mc 0,190 - Kgl 42,3 - N°3</p>  | <p>€ 1.542,00</p>   | <p>Cm 110x80x68-76 h - Mc 0,190 - Kgl 42,5 - N°3</p>   | <p>€ 1.624,00</p>  |
| <p><b>MCN / VTRRE31</b><br/> <b>MCY</b><br/> <b>MQN</b><br/> <b>MQY</b></p>  | <p>ALLUNGO REGISTRABILE CON CASSETTIERA<br/>                 ADJUSTABLE EXTENSION WITH DRAWER BOX<br/>                 RALLONGE RÉGLABLE AVEC CAISSON<br/>                 EXTENSION AJUSTABLE CON CAJONERA</p> <p>MN-MY/VTR1G+MCN-MCY-MQN-MQY/VTR31RE+MV/REPV</p>                  | <p><b>MCN / VTRRE33</b><br/> <b>MCY</b><br/> <b>MQN</b><br/> <b>MQY</b></p>  | <p>ALLUNGO REGISTRABILE CON CASSETTIERA<br/>                 ADJUSTABLE EXTENSION WITH DRAWER BOX<br/>                 RALLONGE RÉGLABLE AVEC CAISSON<br/>                 EXTENSION AJUSTABLE CON CAJONERA</p> <p>MN-MY/VTR1G+MCN-MCY-MQN-MQY/VTR33RE+MV/REPV</p>                   |
| <p>Cm 110x80x68-76 h - Mc 0,348 - Kgl 70,9 - N°3</p>  | <p>€ 2.452,00</p>   | <p>Cm 110x80x68-76 h - Mc 0,348 - Kgl 68,4 - N°3</p>   | <p>€ 2.394,00</p>  |







ALLUNGHI NON REGISTRABILI CON PIANO IN LEGNO  
NOT ADJUSTABLE EXTENSIONS WITH WOODEN TOP  
RALLONGES À NE PAS RÉGABLE AVEC DESSUS EN BOIS  
EXTENSIONES NO AJUSTABLE CON TAPA EN MADERA

COMPONENTI PER ALLUNGHI  
COMPONENTS FOR EXTENSIONS  
COMPOSANTS POUR RALLONGES  
COMPONENTES PARA EXTENSIONES

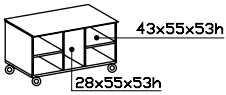
|   |   |   |   |
|---|---|---|---|
| <p><b>MCN / TEG</b><br/><b>MCY</b></p>            | <p>ALLUNGO A GIORNO<br/>OPEN EXTENSION<br/>RALLONGE À CLAIRE VOIE<br/>EXTENSION ABIERTA</p> <p>NM/BAL+MC/ALPS</p>   | <p><b>MCN / TEP</b><br/><b>MCY</b></p>            | <p>ALLUNGO CON ANTE CIECHE<br/>EXTENSION WITH STANDARD DOORS<br/>RALLONGE AVEC PORTES PLEINES<br/>EXTENSION CON PUERTAS LLENAS</p> <p>NM/BAL+MC/ALPS+MC/BBPOA+MN-MY/F1BP</p>  |
| <p>Cm 120x60x72 h - Mc 0,120 - Kgl 39,0 - N°2</p> | <p>€ 807,00</p>   | <p>Cm 120x60x72 h - Mc 0,140 - Kgl 47,4 - N°4</p> | <p>€ 1.320,00</p>   |
| <p><b>MCN / TES</b><br/><b>MCY</b></p>            | <p>ALLUNGO CON SCHEDARI<br/>EXTENSION WITH FILING DRAWERS<br/>RALLONGE AVEC FICHIERS<br/>EXTENSION CON FICHEROS</p> <p>NM/BAL+MC/ALPS+MC/BCSCA+MN-MY/F1CS</p>   |   |   |
| <p>Cm 120x60x72 h - Mc 0,204 - Kgl 56,5 - N°4</p> | <p>€ 1.548,00</p>   |   |   |
| <p><b>MCN / APG</b><br/><b>MCY</b></p>            | <p>ALLUNGO A GIORNO CON GAMBE<br/>OPEN EXTENSION WITH LEGS<br/>RALLONGE À CLAIRE VOIE AVEC PIÉTEMENTS<br/>EXTENSION ABIERTA CON PATA</p> <p>NM/BAL+MN-MY/R2G+MC/ABPS</p>  | <p><b>MCN / APP</b><br/><b>MCY</b></p>            | <p>ALLUNGO CON ANTE CIECHE E GAMBE<br/>EXTENSIONS WITH STANDARD DOORS AND LEGS<br/>RALLONGE AVEC PORTES PLEINES ET PIÉTEMENTS<br/>EXTENSION CON PUERTAS LLENAS Y PATAS</p> <p>NM/BAL+MN-MY/R2G+MC/ABPS+MC/BBPOA+MN-MY/F1BP</p>            |
| <p>Cm 160x60x72 h - Mc 0,193 - Kgl 52,9 - N°3</p> | <p>€ 1.494,00</p>   | <p>Cm 160x60x72 h - Mc 0,211 - Kgl 59,0 - N°5</p> | <p>€ 2.007,00</p>   |
| <p><b>MCN / APS</b><br/><b>MCY</b></p>            | <p>ALLUNGO CON SCHEDARI E GAMBE<br/>EXTENSION WITH FILING DRAWERS AND LEGS<br/>RALLONGE AVEC FICHIERS ET PIÉTEMENTS<br/>EXTENSION CON FICHEROS Y PATAS</p> <p>NM/BAL+MN-MY/R2G+MC/ABPS+MC/BCSCA+MN-MY/F1CS</p>                    |   |   |
| <p>Cm 160x60x72 h - Mc 0,268 - Kgl 68,1 - N°5</p> | <p>€ 2.235,00</p>   |   |   |
| <p><b>MCN / BBPO</b><br/><b>MCY</b></p>           | <p>COPPIA ANTE CIECHE PER:<br/>PAIR OF STANDARD DOORS FOR:<br/>COUPLE DE PORTES PLEINES POUR:<br/>PAR DE PUERTAS LLENAS PARA:<br/>M/TEG-APG</p> <p>MC/BBPOA+MN-MY/F1BP</p>  | <p><b>MCN / BCSC</b><br/><b>MCY</b></p>           | <p>COPPIA CASSETTI SCHEDARIO PER:<br/>PAIR OF FILING DRAWERS FOR:<br/>COUPLE DE TIROIRS FICHER POUR:<br/>PAR DE CAJONES FICHERO PARA:<br/>M/TEG-APG</p> <p>MC/BCSCA+MN-MY/F1CS</p>  |
| <p>Cm 75x1,9x69 h - Mc 0,020 - Kgl 6,8 - N°2</p>  | <p>€ 514,00</p>   | <p>Cm 75x47x69 h - Mc 0,084 - Kgl 17,5 - N°1</p>  | <p>€ 741,00</p>   |
| <p><b>MCN / BBPO/S</b><br/><b>MCY</b></p>         | <p>COPPIA ANTE CIECHE CON SERRATURA PER:<br/>PAIR OF STANDARD DOORS WITH LOCK FOR:<br/>COUPLE DE PORTES PLEINES AVEC SERRURE POUR:<br/>PAR DE PUERTAS LLENAS CON CERRADURA PARA:<br/>M/TEG-APG</p> <p>MC/BBPOA/S+MN-MY/F1BP/S</p> | <p><b>MCN / BCSC/S</b><br/><b>MCY</b></p>         | <p>COPPIA CASSETTI SCHEDARIO CON SERRATURA PER:<br/>PAIR OF FILING DRAWERS WITH LOCK FOR:<br/>COUPLE DE TIROIRS FICHER AVEC SERRURE POUR:<br/>PAR DE CAJONES FICHERO CON CERRADURA PARA:<br/>M/TEG-APG</p> <p>MC/BCSCA/S+MN-MY/F1CS/S</p> |
| <p>Cm 75x1,9x69 h - Mc 0,020 - Kgl 6,8 - N°2</p>  | <p>€ 627,00</p>   | <p>Cm 75x47x69 h - Mc 0,084 - Kgl 17,5 - N°1</p>  | <p>€ 897,00</p>   |

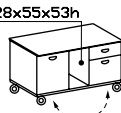
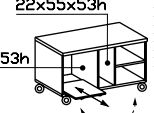
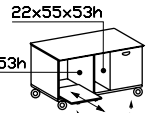

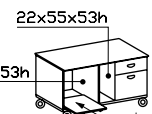
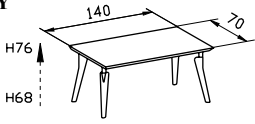
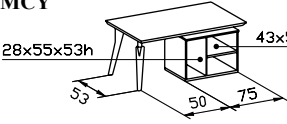
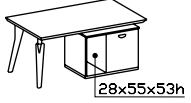
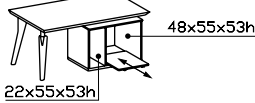
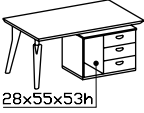
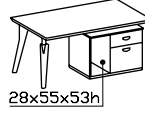



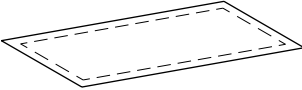
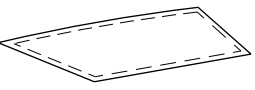
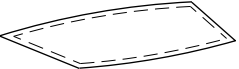

**GLI ELEMENTI MC-MQ/ERG-ERP-ERSG-EXSG-EXSP-EXS31-EXS33 SONO DOTATI DI VANO PORTA UNITÀ CENTRALE CON GRIGLIA DI AERAZIONE**  
**THE ELEMENTS MC-MQ/ERG-ERP-ERSG-EXSG-EXSP-EXS31-EXS33 ARE EQUIPPED WITH A SPACE FOR COMPUTER CENTRAL UNIT WITH AERATION GRID**  
**LES ÉLÉMENTS MC-MQ/ERG-ERP-ERSG-EXSG-EXSP-EXS31-EXS33 SONT DOTÉS DE ESPACE POUR UNITÉ CENTRALE DE ORDINATEUR AVEC GRILLE DE AÉRATION**  
**LOS ELEMENTOS MC-MQ/ERG-ERP-ERSG-EXSG-EXSP-EXS31-EXS33 ESTÁN EQUIPADOS DE ESPACIO PORTA UNIDAD CENTRAL ORDENADOR CON JILLA DE AIREACIÓN**

|   |  |  |   |  |   |  |  |  |
|---|--|--|---|--|---|--|--|--|
| ALLUNGHI NOMADI CON PIANO IN LEGNO<br>MOVABLE EXTENSIONS WITH WOODEN TOP<br>RALLONGES MOUVANTES AVEC DESSUS EN BOIS<br>EXTENSIONES DESPLAZABLES CON PLANO EN MADERA | <b>MCN / EXG</b><br><b>MCY</b><br><b>MQN</b><br><b>MQY</b>   | ALLUNGO A GIORNO<br>OPEN EXTENSION<br>EXTENSION À CLAIRE VOIE<br>EXTENSIÓN ABIERTA   |    | <b>MCN / EXP</b><br><b>MCY</b><br><b>MQN</b><br><b>MQY</b>   | ALLUNGO CON ANTE CIECHE<br>EXTENSION WITH STANDARD DOORS<br>RALLONGE AVEC PORTES PLEINES<br>EXTENSIÓN CON PUERTAS LLENAS  |    | MC-MQ/EXTB+TM/EXFS+<br>N.2 MC-MQ/EXPOA+N.2 MN-MY/F5BP                  |  |
|   | Cm 120x63x69 h - Mc 0,148 - Kgl 59,0 - N°2   | <b>€ 641,00</b>  | Cm 120x63x69 h - Mc 0,176 - Kgl 67,4 - N°6  | <b>€ 1.120,00</b>  |   |  |  |  |
|   | <b>MCN / EX31</b><br><b>MCY</b><br><b>MQN</b><br><b>MQY</b>  | ALLUNGO CON ANTA CIECA E CASSETTIERA<br>EXTENSION WITH STANDARD DOOR+DRAWER UNIT<br>RALLONGE AVEC PORTE PLEINE+CAISSON À TIROIRS<br>EXTENSIÓN CON PUERTA LLENA Y CAJONERA  |    | <b>MCN / EX33</b><br><b>MCY</b><br><b>MQN</b><br><b>MQY</b>  | ALLUNGO CON ANTA CIECA E CASSETTIERA<br>EXTENSION WITH STANDARD DOOR+DRAWER UNIT<br>RALLONGE AVEC PORTE PLEINE+CAISSON À TIROIRS<br>EXTENSIÓN CON PUERTA LLENA Y CAJONERA   |    | MC-MQ/EXTB+TM/EXFS+MC-MQ/EXPOA+<br>MCN-MCY-MQN-MQY/31EX+MN-MY/F5BP     | MC-MQ/EXTB+TM/EXFS+MC-MQ/EXPOA+<br>MCN-MCY-MQN-MQY/33EX+MN-MY/F5BP |
|   | Cm 120x63x69 h - Mc 0,403 - Kgl 91,6 - N°5   | <b>€ 1.738,00</b>  | Cm 120x63x69 h - Mc 0,403 - Kgl 89,1 - N°5  | <b>€ 1.701,00</b>  |   |  |  |  |
|   | <b>MCN / EXSG</b><br><b>MCY</b><br><b>MQN</b><br><b>MQY</b>  | ALLUNGO A GIORNO CON PORTA UNITÀ E STAMPANTE<br>OPEN EXTENSION WITH SUPPORT FOR CENTRAL UNIT AND<br>PRINTER<br>RALLONGE À CLAIRE VOIE+SUPPORT UNITÉ CENTRALE+IMPRIMANTE<br>EXTENSIÓN ABIERTA CON SOPORTE UNIDAD CENTRAL Y<br>IMPRESORA |    | <b>MCN / EXSP</b><br><b>MCY</b><br><b>MQN</b><br><b>MQY</b>  | ALLUNGO CON ANTA CIECA, PORTA UNITÀ E STAMPANTE<br>EXTENSION WITH STANDARD DOOR+SUPPORT CENTRAL<br>UNIT+PRINTER<br>RALLONGE AVEC PORTE PLEINE+SUPPORT UNITÉ CENTRALE+<br>IMPRIMANTE<br>EXTENSIÓN CON PUERTA LLENA+SOPORTE UNIDAD<br>CENTRAL+IMPRESORA |    | MC-MQ/EXTB+TM/EXSFS+TM/EXSTA+<br>MC-MQ/EXPOA+MN-MY/F5BP                |  |
| Cm 120x63x69 h - Mc 0,189 - Kgl 63,4 - N°3  | <b>€ 878,00</b>  | Cm 120x63x69 h - Mc 0,203 - Kgl 67,6 - N°5   | <b>€ 1.117,00</b>   |  |   |  |  |  |
| <b>MCN / EXS31</b><br><b>MCY</b><br><b>MQN</b><br><b>MQY</b>  | ALLUNGO CON CASSETTIERA, PORTA UNITÀ E STAMPANTE<br>EXTENSION WITH DRAWER UNIT+SUPPORT CENTRAL UNIT+PRINTER<br>EXTENSION AVEC CAISSON+SUPPORT UNITÉ CENTRALE+IMPRIMANTE<br>EXTENSIÓN CON CAJONERA+SOPORTE UNIDAD CENTRAL+IMPRESORA |   | <b>MCN / EXS33</b><br><b>MCY</b><br><b>MQN</b><br><b>MQY</b>                        | ALLUNGO CON CASSETTIERA, PORTA UNITÀ E STAMPANTE<br>EXTENSION WITH DRAWER UNIT+SUPPORT CENTRAL<br>UNIT+PRINTER<br>EXTENSION AVEC CAISSON+SUPPORT UNITÉ CENTRALE+IMPRIMANTE<br>EXTENSIÓN CON CAJONERA+SOPORTE UNIDAD<br>CENTRAL+IMPRESORA |   | MC-MQ/EXTB+TM/EXSFS+TM/EXSTA+<br>MCN-MCY-MQN-MQY/31EX                                | MC-MQ/EXTB+TM/EXSFS+TM/EXSTA+<br>MCN-MCY-MQN-MQY/33EX                  |  |
| Cm 120x63x69 h - Mc 0,440 - Kgl 96,0 - N°4  | <b>€ 1.735,00</b>  | Cm 120x63x69 h - Mc 0,440 - Kgl 93,5 - N°4   | <b>€ 1.698,00</b>   |  |   |  |  |  |
| ALLUNGHI FISSI CON PIANO IN LEGNO<br>FIX EXTENSIONS WITH WOODEN TOP<br>RALLONGES FIXES AVEC DESSUS EN BOIS<br>EXTENSIONES FIJAS CON PLANO EN MADERA                 | <b>MCN / ERTA</b><br><b>MCY</b>  | ALLUNGO SAGOMATO REGISTRABILE<br>ADJUSTABLE SHAPED EXTENSION<br>RALLONGE RÉGLABLE FAÇONNÉ<br>EXTENSIÓN CURVADA AJUSTABLE   |  | <b>MCN / ERG</b><br><b>MCY</b>   | ALLUNGO A GIORNO<br>OPEN EXTENSION<br>RALLONGE À CLAIRE VOIE<br>EXTENSIÓN ABIERTA   |  | N.2 MN-MY/R2G+MC/ERPS  | TM/ERTB+TM/ERFS+TM/ERCOL+<br>MN-MY/R2G+MC/ERPS                     |
|   | Cm 140x70x72 h - Mc 0,184 - Kgl 85,2 - N°3   | <b>€ 1.598,00</b>  | Cm 140x70x72 h - Mc 0,247 - Kgl 85,2 - N°5  | <b>€ 1.558,00</b>  |   |  |  |  |
|   | <b>MCN / ERP</b><br><b>MCY</b>   | ALLUNGO CON PORTA CIECA<br>EXTENSION WITH STANDARD DOOR<br>RALLONGE AVEC PORTE PLEINE<br>EXTENSIÓN CON PUERTA LLENA  |  | <b>MCN / ERSG</b><br><b>MCY</b>  | ALLUNGO PORTA STAMPANTE<br>EXTENSIONS AS PRINTER SUPPORT<br>RALLONGE PORTE-IMPRIMANTE<br>EXTENSIÓN PORTAIMPRESORA   |  | TM/ERTB+TM/ERCOL+TM/ERFS+<br>MN-MY/R2G+MC/ERPS+MC/EXPOA+<br>MN-MY/F5BP | TM/ERTB+TM/ERCOL+TM/ERFS+<br>TM/EXSTA+MN-MY/R2G+MC/ERPS            |
|   | Cm 140x70x72 h - Mc 0,261 - Kgl 89,4 - N°7   | <b>€ 1.797,00</b>  | Cm 140x70x72 h - Mc 0,288 - Kgl 91,7 - N°6  | <b>€ 1.727,00</b>  |   |  |  |  |
|   | <b>MCN / ER31</b><br><b>MCY</b>  | ALLUNGO CON CASSETTIERA<br>EXTENSION WITH DRAWER BOX<br>RALLONGE AVEC CAISSON<br>EXTENSIÓN CON CAJONERA  |  | <b>MCN / ER33</b><br><b>MCY</b>  | ALLUNGO CON CASSETTIERA<br>EXTENSION WITH DRAWER BOX<br>RALLONGE AVEC CAISSON<br>EXTENSIÓN CON CAJONERA   |  | TM/ERTB+TM/ERCOL+TM/ERFS+<br>MN-MY/R2G+MC/ERPS+MCN-MCY/31EX            | TM/ERTB+TM/ERCOL+TM/ERFS+<br>MN-MY/R2G+MC/ERPS+MCN-MCY/33EX        |
| Cm 140x70x72 h - Mc 0,502 - Kgl 117,8 - N°6   | <b>€ 2.415,00</b>  | Cm 140x70x72 h - Mc 0,502 - Kgl 115,3 - N°6  | <b>€ 2.378,00</b>   |  |   |  |  |  |

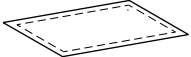



|   |   |   |   |                         |   |   |  |                            |
|---|---|---|---|-------------------------|---|---|--|----------------------------|
| COMPONENTI PER ALLUNGHI<br>COMPONENTS FOR EXTENSIONS<br>COMPOSANTS POUR RALLONGES<br>COMPONENTES PARA EXTENSIONES   | <b>MCN / EXPO</b><br><b>MCY</b><br><b>MQN</b><br><b>MQY</b>   | ANTA SINGOLA CIECA DESTRA O SINISTRA PER:<br>RIGHT OR LEFT SINGLE STANDARD DOOR FOR:<br>PORTE PLEINE DROIT OU GAUCHE SINGLE POUR:<br>PUERTA SIMPLE LLENA DERECHO O IZQUIERDO PARA:<br>M/EXG-EXSG-ERG            |   | MCN-MQ/EXPOA+MN-MY/F5BP | <b>MCN / EXPO/S</b><br><b>MCY</b><br><b>MQN</b><br><b>MQY</b> | ANTA SINGOLA CIECA CON SERRATURA PER:<br>SINGLE STANDARD DOOR WITH LOCK FOR:<br>PORTE PLEINE SINGLE AVEC SERRURE POUR:<br>PUERTA SIMPLE LLENA CON CERRADURA PARA:<br>M/EXG-EXSG-ERG                             |  | MC-MQ/EXPOA/S+MN-MY/F5BP/S |
|   | Cm 46x1,9x53 h - Mc 0,014 - Kgl 4,2 - N°2                     | <b>€ 240,00</b>   | Cm 46x1,9x53 h - Mc 0,014 - Kgl 4,2 - N°2 | <b>€ 353,00</b>         |   |   |  |                            |
|   | <b>MCN / 31EX</b><br><b>MCY</b><br><b>MQN</b><br><b>MQY</b>   | CASSETTIERA INSERIBILE DESTRA O SINISTRA PER:<br>RIGHT OR LEFT DRAWER UNIT TO INSERT INTO:<br>CAISSON À TIROIRS DROIT OU GAUCHE À INSÉRER EN:<br>CAJONERA PARA MONTAR DERECHO O IZQUIERDO EN:<br>M/EXG-EXSG-ERG |   | MCN-MCY-MQN-MQY/31EX    | <b>MCN / 33EX</b><br><b>MCY</b><br><b>MQN</b><br><b>MQY</b>   | CASSETTIERA INSERIBILE DESTRA O SINISTRA PER:<br>RIGHT OR LEFT DRAWER UNIT TO INSERT INTO:<br>CAISSON À TIROIRS DROIT OU GAUCHE À INSÉRER EN:<br>CAJONERA PARA MONTAR DERECHO O IZQUIERDO EN:<br>M/EXG-EXSG-ERG |  | MCN-MCY-MQN-MQY/33EX       |
|   | Cm 46x57x53 h - Mc 0,255 - Kgl 32,6 - N°1                     | <b>€ 857,00</b>   | Cm 46x57x53 h - Mc 0,255 - Kgl 32,6 - N°1 | <b>€ 821,00</b>         |   |   |  |                            |
| CASSETTIERE IN MELAMINICO CON TOP E FRONTALI IN LEGNO<br>DRAWER BOXES WITH WOODEN TOP AND FRONTAL PANELS<br>CAISSONS AVEC DESSUS ET FRONTS EN BOIS<br>CAJONERAS EN MELAMÍNICO CON TAPA Y FRONTALES EN MADERA        | <b>MCN / PR31</b><br><b>MCY</b><br><b>MQN</b><br><b>MQY</b>   | CASSETTIERA MELAMINICA CON RUOTE<br>MELAMINE DRAWER BOX ON CASTORS<br>CAISSON EN MÉLAMINÉ SUR ROULETTES<br>CAJONERA EN MELAMÍNICO CON RUEDAS  |   | MCN-MCY-MQN-MQY/PR31    | <b>MCN / PR33</b><br><b>MCY</b><br><b>MQN</b><br><b>MQY</b>   | CASSETTIERA MELAMINICA CON RUOTE<br>MELAMINE DRAWER BOX ON CASTORS<br>CAISSON EN MÉLAMINÉ SUR ROULETTES<br>CAJONERA EN MELAMÍNICO CON RUEDAS  |  | MCN-MCY-MQN-MQY/PR33       |
|   | Cm 42x59x56 h - Mc 0,213 - Kgl 31,5 - N°1                     | <b>€ 1.097,0</b>  | Cm 42x59x56 h - Mc 0,213 - Kgl 29,0 - N°1 | <b>€ 1.039,0</b>        |   |   |  |                            |
|   | <b>MCN / PR31PC</b><br><b>MCY</b><br><b>MQN</b><br><b>MQY</b> | CASSETTIERA+PORTACANCELLERIA INTERNO<br>DRAWER BOX+INTERNAL STATIONERY TRAY<br>CAISSON+TIROIR PLUMIER INTERNE<br>CAJONERA+CAJÓN PARA MATERIAL DE OFICINA  |   | MCN-MCY-MQN-MQY/PR31PC  | <b>MCN / PR33PC</b><br><b>MCY</b><br><b>MQN</b><br><b>MQY</b> | CASSETTIERA+PORTACANCELLERIA INTERNO<br>DRAWER BOX+INTERNAL STATIONERY TRAY<br>CAISSON+TIROIR PLUMIER INTERNE<br>CAJONERA+CAJÓN PARA MATERIAL DE OFICINA  |  | MCN-MCY-MQN-MQY/PR33PC     |
|   | Cm 42x59x56 h - Mc 0,213 - Kgl 32,5 - N°1                     | <b>€ 1.202,0</b>  | Cm 42x59x56 h - Mc 0,213 - Kgl 30,0 - N°1 | <b>€ 1.144,0</b>        |   |   |  |                            |
| ACCESSORI PER CASSETTIERE<br>ACCESSORIES FOR DRAWER BOXES<br>ACCESSOIRES POUR CAISSONS<br>ACCESORIOS PARA CAJONERAS   | <b>NK / VPAC</b>  | PORTACANCELLERIA MOBILE PER CASSETTIERE<br>MOVABLE STATIONERY TRAY FOR DRAWER BOXES<br>TIROIR PLUMIER MOUVANT POUR CAISSONS<br>CAJÓN MÓVIL PARA MATERIAL DE OFICINA   |   | NK/VPAC                 | <b>BK / CDPR</b>  | SUPPORTO PER N° 15÷18 C. D. PER CASSETTI SCHEDARIO<br>SUPPORT FOR 15÷18 C. D. FOR FILING DRAWERS<br>SUPPORT POUR 15÷18 C. D. POUR TIROIRS FICHER<br>SOPORTE PARA 15÷18 C. D. PARA CAJONES FICHERO               |  | BK/CDPR                    |
|   | Cm 36x16x3 h - Mc 0,001 - Kgl 0,2 - N°1                       | <b>€ 19,00</b>  | Cm 33x18X17 h - Mc 0,011 - Kgl 2,5 - N°1  | <b>€ 71,00</b>          |   |   |  |                            |
|   | <b>B / 105CPL</b>   | CARTELLA SCHEDARIO<br>FILE FOR FILING DRAWER<br>DOSSIER POUR FICHER<br>CARPETA PARA FICHERO   |   | B/105CPL                | <b>B / 106CPL</b>   | CARTELLA SCHEDARIO<br>FILE FOR FILING DRAWER<br>DOSSIER POUR FICHER<br>CARPETA PARA FICHERO   |  | B/106CPL                   |
|   | Cm 33x25 h - Mc 0,001 - Kgl 0,11 - N°1                        | <b>€ 2,70</b>   | Cm 39x25 h - Mc 0,001 - Kgl 0,11 - N°1    | <b>€ 2,80</b>           |   |   |  |                            |
| <b>COME UTILIZZARE IL CASSETTO SCHEDARIO DELLE CASSETTIERE</b><br>HOW TO USE THE FILING DRAWER OF THE DRAWER BOXES<br>COMMENT UTILISER LE TIROIR FICHER DES CAISSONS<br>CÓMO USAR EL CAJÓN FICHERO DE LAS CAJONERAS |   |   |   |                         |   |   |  |                            |

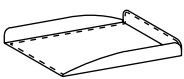
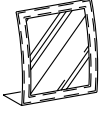
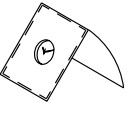
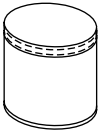
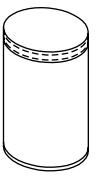
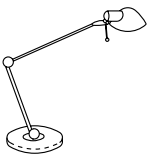
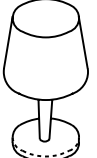

|  |  |  |
|--|--|--|
| ACCESSORI<br>ACCESSORIES<br>ACCESSOIRES<br>ACCESORIOS  | <p><b>MN / S14A</b><br/><b>MY</b></p>  <p>SOTTOMANO PER SCRIVANIA:<br/>DESK PAD FOR WRITING DESK:<br/>SOUS-MAIN POUR BUREAU:<br/>VADE PARA ESCRITORIO:<br/>M/140RA</p> <p>MN-MY/S14A</p>  | <p><b>MN / S18</b><br/><b>MY</b></p>  <p>SOTTOMANO PER SCRIVANIA:<br/>DESK PAD FOR WRITING DESK:<br/>SOUS-MAIN POUR BUREAU:<br/>VADE PARA ESCRITORIO:<br/>M/140RA-180R-180C</p> <p>MN-MY/S18</p>   |
|  | <p>Cm 138x71 - Mc 0,010 - Kgl 13 - N°1</p> <p style="text-align: right;"><b>€ 712,00</b></p>   | <p>Cm 90x52 - Mc 0,005 - Kgl 6,0 - N°1</p> <p style="text-align: right;"><b>€ 367,00</b></p>   |
|  | <p><b>MN / S20B</b><br/><b>MY</b></p>  <p>SOTTOMANO PER SCRIVANIA:<br/>DESK PAD FOR WRITING DESK:<br/>SOUS-MAIN POUR BUREAU:<br/>VADE PARA ESCRITORIO:<br/>M/200RB-200BC</p> <p>MN-MY/S20B</p>                                    | <p><b>MN / S22C</b><br/><b>MY</b></p>  <p>SOTTOMANO PER SCRIVANIA:<br/>DESK PAD FOR WRITING DESK:<br/>SOUS-MAIN POUR BUREAU:<br/>VADE PARA ESCRITORIO:<br/>M/180RF-180RZD-180RZS-180FC-180ZDC-180ZSC-220RC-220CC-220RD-220DC</p> <p>MN-MY/S22C</p> |
|  | <p>Cm 86x50 - Mc 0,005 - Kgl 6,0 - N°1</p> <p style="text-align: right;"><b>€ 363,00</b></p>   | <p>Cm 90x52 - Mc 0,005 - Kgl 6,2 - N°1</p> <p style="text-align: right;"><b>€ 367,00</b></p>   |
|  | <p><b>MN / STA</b><br/><b>MY</b></p>  <p>SOTTOMANO PER TAVOLO RIUNIONI:<br/>DESK PAD FOR MEETING TABLE:<br/>SOUS-MAIN POUR TABLE DE RÉUNION:<br/>VADE PARA MESA DE REUNIÓN:<br/>M/140RA-280RTA-420RTA-560RTA</p> <p>MN-MY/STA</p> |  |
|  | <p>Cm 53x35 - Mc 0,002 - Kgl 2,8 - N°1</p> <p style="text-align: right;"><b>€ 302,00</b></p>   |  |
|  | <p><b>MN / E3</b><br/><b>MY</b></p>  <p>PORTA TELEFONINO<br/>MOBILE PHONE HOLDER<br/>PORTE TÉLÉPHONE MOBILE<br/>PORTATELEFONO CELULAR</p> <p>MN-MY/E3</p>   | <p><b>MN / N4</b><br/><b>MY</b></p>  <p>POSACENERE<br/>ASHTRAY<br/>CENDRIER<br/>CENICERO</p> <p>MN-MY/N4</p>   |
|  | <p>Cm 6x13x6 h - Mc 0,001 - Kgl 0,7 - N°1</p> <p style="text-align: right;"><b>€ 109,00</b></p>  | <p>Cm 15x15x4 h - Mc 0,008 - Kgl 0,7 - N°1</p> <p style="text-align: right;"><b>€ 158,00</b></p>   |
|  | <p><b>MN / T6</b><br/><b>MY</b></p>  <p>TAGLIACARTE<br/>PAPER-KNIFE<br/>COUPE-PAPIER<br/>ABRE CARTAS</p> <p>MN-MY/T6</p>  | <p><b>MN / F7</b><br/><b>MY</b></p>  <p>PORTA BIGLIETTI<br/>CARDS HOLDER<br/>PORTE-BILLETTS<br/>TARJETERO PARA ESCRITORIO</p> <p>MN-MY/F7</p>  |
|  | <p>Cm ø1,5x22 - Mc 0,004 - Kgl 0,2 - N°1</p> <p style="text-align: right;"><b>€ 103,00</b></p>   | <p>Cm 15x10x6 h - Mc 0,003 - Kgl 0,3 - N°1</p> <p style="text-align: right;"><b>€ 79,00</b></p>  |
|  | <p><b>MN / P8</b><br/><b>MY</b></p>  <p>PORTA PENNE<br/>PEN HOLDER<br/>PORTE-CRAYONS<br/>PORTALÁPICES</p> <p>MN-MY/P8</p>   | <p><b>MN / C9</b><br/><b>MY</b></p>  <p>PORTA CARTE<br/>PAPER TRAY<br/>PORTE-PAPIERS<br/>PORTAPAPELES</p> <p>MN-MY/C9</p>  |
|  | <p>Cm ø8x10 h - Mc 0,005 - Kgl 0,3 - N°1</p> <p style="text-align: right;"><b>€ 89,00</b></p>  | <p>Cm 32x23x5 h - Mc 0,005 - Kgl 2,0 - N°1</p> <p style="text-align: right;"><b>€ 143,00</b></p>   |
|  | <p><b>MN / R11</b><br/><b>MY</b></p>  <p>PORTARITRATTO<br/>PHOTOGRAPH FRAME<br/>PORTE-PORTRAIT<br/>PORTARETRATO</p> <p>MN-MY/R11</p>  | <p><b>MN / S17</b><br/><b>MY</b></p>  <p>OROLOGIO DA TAVOLO<br/>DESK CLOCK<br/>HORLOGE DE BUREAU<br/>RELOJ DE MESA</p> <p>MN-MY/S17</p>  |
|  | <p>Cm 24x9x20 h - Mc 0,005 - Kgl 1,2 - N°1</p> <p style="text-align: right;"><b>€ 309,00</b></p>   | <p>Cm 9x13x9 h - Mc 0,002 - Kgl 1,1 - N°1</p> <p style="text-align: right;"><b>€ 505,00</b></p>  |
|  | <p><b>MN / G10</b><br/><b>MY</b></p>  <p>GETTA CARTE<br/>WASTE-PAPER BASKET<br/>CORBEILLE À PAPIERS<br/>PAPELERO</p> <p>MN-MY/G10</p>   | <p><b>MN / PO23</b><br/><b>MY</b></p>  <p>PORTA OMBRELLI<br/>UMBRELLA-STAND<br/>PORTE-PARAPLUIES<br/>PARAGÜERO</p> <p>MN-MY/PO23</p>   |
|  | <p>Cm ø25x33 h - Mc 0,027 - Kgl 2,0 - N°1</p> <p style="text-align: right;"><b>€ 187,00</b></p>  | <p>Cm ø25x51 h - Mc 0,035 - Kgl 2,5 - N°1</p> <p style="text-align: right;"><b>€ 203,00</b></p>  |
| <p><b>MN / L2</b><br/><b>MY</b></p>  <p>LAMPADA DA TAVOLO<br/>DESK LAMP<br/>LAMPE DE BUREAU<br/>LÁMPARA DE MESA</p> <p>MN-MY/L2</p> | <p><b>MN / L14</b><br/><b>MY</b></p>  <p>LAMPADA DA TAVOLO<br/>DESK LAMP<br/>LAMPE DE BUREAU<br/>LÁMPARA DE MESA</p> <p>M/L14/A+MN-MY/L14/B</p>  |  |
| <p>Cm 25x78x55 h - Mc 0,008 - Kgl 3,8 - N°1</p> <p style="text-align: right;"><b>€ 472,00</b></p>  | <p>Cm ø40x65 h - Mc 0,165 - Kgl 7,5 - N°2</p> <p style="text-align: right;"><b>€ 769,00</b></p>  |  |



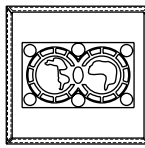
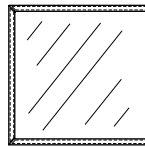
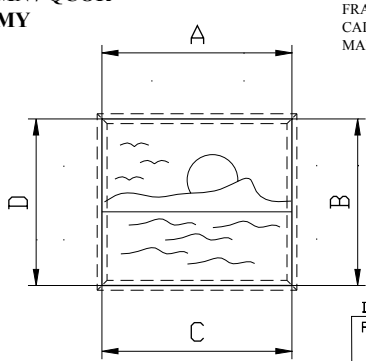



|   |   |   |  |                   |
|---|---|---|--|-------------------|
| ACCESSORI<br>ACCESSORIES<br>ACCESSOIRES<br>ACCESORIOS   | <b>DM / OR29</b><br><br>OROLOGIO DA PARETE<br>WALL CLOCK<br>HORLOGE<br>RELOJ DE PARED<br>DM/OR29   |   |  |                   |
|   | Cm ø40x3 h - Mc 0,022 - Kgl 0,6 - N°1   | <b>€ 183,00</b>   |  |                   |
|   | <b>MN / L16 MY</b><br><br>LAMPADA DA TERRA<br>STANDING LAMP<br>LAMPE À TERRE<br>LÁMPARA DE PISO<br>MN-MY/L16   | <b>MN / A22 MY</b><br><br>APPENDIABITI<br>COAT-STAND<br>PORTE-MANTEAUX<br>PERCHERO<br>MN-MY/A22/A+MM/A22/B |  |                   |
|   | Cm ø32x189 h - Mc 0,170 - Kgl 9,7 - N°1   | <b>€ 868,00</b>   | Cm ø45x167 h - Mc 0,220 - Kgl 17,4 - N°2 | <b>€ 521,00</b>   |
| ACCESSORI INSERIBILI<br>ACCESSORIES TO INSERT<br>ACCESSOIRES À INSÉRER<br>ACCESORIOS POR INSTALAR | <b>MN / CG25 MY</b><br><br>CARTA GEOGRAFICA<br>MAP<br>CARTE GÉOGRAPHIQUE<br>MAPA<br>MN-MY/CG25   | <b>MN / SP26 MY</b><br><br>SPECCHIO<br>MIRROR<br>MIROIR<br>ESPEJO<br>MN-MY/SP26                             |  |                   |
|   | Cm 121x87 - Mc 0,077 - Kgl 17,2 - N°1   | <b>€ 2.277,00</b>   | Cm 121x87 - Mc 0,077 - Kgl 17,9 - N°1    | <b>€ 2.129,00</b> |
| CORNICE PER QUADRI<br>PICTURE FRAME<br>CADRES POUR TABLEAU<br>MARCOS PARA CUADRO                  | <p><b>CORNICE SU MISURA IN ALLUMINIO RIVESTITO IN CUOIO PER TELE DEL CLIENTE MAX 2 cm DI SPESSORE, SORMONTO CORNICE 1 cm. PREZZO AL ml (A+B+C+D), MINIMO FATTURABILE ml 1,60.</b></p> <p>ALUMINIUM FRAME TO MEASURE COVERED WITH LEATHER FROM CUSTOM'S PICTURES, MAX WIDTH OF 2 cm, 1 cm FRAME SURMOUNT. PRICE PER m (A+B+C+D), INVOICE FOR MINIMUM m 1,60.</p> <p>CADRE SUR MESURE EN ALUMINIUM REVÊTU EN CUIR POUR LES TOILES DU CLIENT, MAX ÉPAISSEUR 2 cm, DÉPASSEMENT DU CADRE 1 cm. PRIX PAR m (A+B+C+D), À FACTURER MINIMUM m 1,60.</p> <p>MARCO A MEDIDA EN ALUMINIO RIVESTIDO EN CUERO PARA TELAS DEL CLIENTE, 2 cm DE ESPESOR MÁX, SOLAPE DEL MARCO 1 cm. PRECIO AL m (A+B+C+D), MINIMO CALCULADO 1,60 m.</p> |   |  |                   |
|   | <b>MN / QCOR MY</b><br><br>CORNICE SU MISURA<br>FRAME TO MEASURE<br>CADRE SUR MESURE<br>MARCO A MEDIDA<br>DIMENSIONE DEL QUADRO<br>PICTURE DIMENSION<br>ml = A+B+C+D   |   |  |                   |
|   |   |   |  |                   |
|   | Mc 0,050 - Kgl 7,5 - N°1  | <b>€/ml 415,00</b>  |  |                   |



**LE LIBRERIE ANGOLARI SE USATE SINGOLARMENTE DEVONO ESSERE ASSICURATE AD UNA PARETE DI SOSTEGNO**

**IF THE CORNER BOOKCASES ARE USED SEPARATELY THEY MUST BE SECURED TO A SUPPORTING WALL**

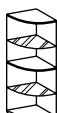
**SI LES BIBLIOTHÈQUES ANGULAIRES SONT UTILISÉES INDIVIDUELLEMENT ELLES DOIVENT ÊTRE ASSURÉES À UNE CLOISON DE SUPPORT**

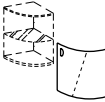
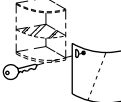
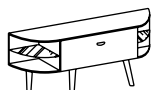
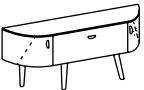
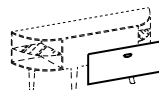
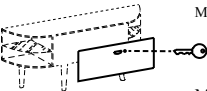
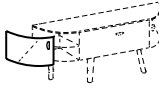
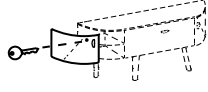
**SI LAS BIBLIOTECAS ANGULARES SE USAN DE FORMA INDIVIDUAL ES NECESARIO FIJARLAS A UNA PARED DE SOSTÉN**

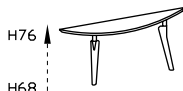
|   |   |   |   |   |   |  |
|---|---|---|---|---|---|--|
| LIBRERIE CON PIANO IN LEGNO<br>BOOKCASES WITH WOODEN TOP<br>BIBLIOTHÈQUES AVEC DESSUS EN BOIS<br>BIBLIOTECAS CON TAPA DE MADERA | <p><b>MCN / AB / O</b><br/><b>MCY</b><br/><b>MQN</b><br/><b>MQY</b></p>  | <p>LIBRERIA ANGOLARE A GIORNO<br/>ANGULAR OPEN BOOKCASE<br/>BIBLIOTHÈQUE ANGULAIRE À CLAIRE VOIE<br/>BIBLIOTECA ESQUINERA SIN PUERTAS</p> <p>MM/FAB+MC-MQ/PLAB</p>            | <p><b>MCN / AB</b><br/><b>MCY</b><br/><b>MQN</b><br/><b>MQY</b></p>    | <p>LIBRERIA ANGOLARE CON ANTA CIECA<br/>ANGULAR BOOKCASE WITH STANDARD DOOR<br/>BIBLIOTHÈQUE ANGULAIRE AVEC PORTE PLEINE<br/>BIBLIOTECA ESQUINERA CON PUERTA LLENA</p> <p>MM/FAB+MC-MQ/PLAB+MN-MY/ABPOA+MN-MY/FABP</p>  | <p>Cm 48x48x77 h - Mc 0,057 - Kgl 19,8 - N°2</p> <p><b>€ 659,00</b></p>   | <p>Cm 48x48x77 h - Mc 0,220 - Kgl 27,8 - N°4</p> <p><b>€ 1.304,00</b></p>  |
|   | <p><b>MCN / AA / O</b><br/><b>MCY</b><br/><b>MQN</b><br/><b>MQY</b></p>  | <p>LIBRERIA ANGOLARE A GIORNO<br/>ANGULAR OPEN BOOKCASE<br/>BIBLIOTHÈQUE ANGULAIRE À CLAIRE VOIE<br/>BIBLIOTECA ESQUINERA SIN PUERTAS</p> <p>MM/FAA+MC-MQ/PLAB+MC-MQ/PLAA</p> | <p><b>MCN / AA</b><br/><b>MCY</b><br/><b>MQN</b><br/><b>MQY</b></p>    | <p>LIBRERIA ANGOLARE A GIORNO CON ANTA CIECA<br/>OPEN ANGULAR BOOKCASE WITH STANDARD DOOR<br/>BIBLIOTHÈQUE À CLAIRE VOIE AVEC PORTE PLEINE<br/>BIBLIOTECA ESQUINERA SIN PUERTAS Y PUERTA LLENA</p> <p>MM/FAA+MC-MQ/PLAB+MC-MQ/PLAA+MN-MY/ABPOA+MN-MY/FABP</p> | <p>Cm 48x48x147 h - Mc 0,107 - Kgl 36,8 - N°3</p> <p><b>€ 1.089,00</b></p>  | <p>Cm 48x48x147 h - Mc 0,270 - Kgl 44,8 - N°5</p> <p><b>€ 1.735,00</b></p> |
| ANTE PER LIBRERIA<br>DOORS FOR BOOKCASE<br>PORTES POUR BIBLIOT.<br>PUERTAS PARA BIBLIOTECA                                      | <p><b>MN / ABPO</b><br/><b>MY</b></p>                                    | <p>ANTA SINGOLA CIECA PER:<br/>SINGLE STANDARD DOOR FOR:<br/>PORTE PLEINE SINGLE POUR:<br/>PUERTA SIMPLE LLENA PARA:<br/>M/AB/O-AA/O</p> <p>MN-MY/ABPOA+MN-MY/FABP</p>        | <p><b>MN / ABPO/S</b><br/><b>MY</b></p>   | <p>ANTA SINGOLA CIECA CON SERRATURA PER:<br/>SINGLE STANDARD DOOR WITH LOCK FOR:<br/>PORTE PLEINE SINGLE AVEC SERRURE POUR:<br/>PUERTA SIMPLE LLENA CON CERRADURA PARA:<br/>M/AB/O-AA/O</p> <p>MN-MY/ABPOA/S+MN-MY/FABP/A</p>                                 | <p>Cm 48x1,9x77 h - Mc 0,163 - Kgl 8,0 - N°2</p> <p><b>€ 646,00</b></p>   | <p>Cm 48x1,9x77 h - Mc 0,163 - Kgl 8,0 - N°2</p> <p><b>€ 791,00</b></p>    |
|   | LIBRERIE CON ANTA A RIBALTA<br>BOOKCASES WITH DROP-LEAF DOOR<br>BIBLIOTHÈQUES AVEC PORTE ABATTANTE<br>BIBLIOTECAS CON PUERTA ABATIBLE                     | <p><b>MCN / LB/O</b><br/><b>MCY</b><br/><b>MQN</b><br/><b>MQY</b></p>                      | <p>LIBRERIA CON 1 ANTA A RIBALTA<br/>BOOKCASE WITH 1 DROP-LEAF DOOR<br/>BIBLIOTHÈQUE AVEC 1 PORTE ABATTANTE<br/>BIBLIOTECA CON 1 PUERTA ABATIBLE</p> <p>MM/LEF+MM/LEBS+MC-MQ/PLL+MM/4GA+MC-MQ/LRPOA+MN-MY/F5LRP</p> | <p><b>MCN / LB</b><br/><b>MCY</b><br/><b>MQN</b><br/><b>MQY</b></p>   | <p>LIBRERIA CON 1 ANTA A RIBALTA E 2 CURVE IN CUIO<br/>BOOKCASE WITH 1 DROP-LEAF DOOR + 2 CURVE LEATHER DOORS<br/>BIBLIOTHÈQUE AVEC 1 PORTE ABATTANTE ET 2 COURBE EN CUIR<br/>BIBLIOTECA CON 1 PUERTA ABATIBLE Y 2 ENCURVADAS DE CUERO</p> <p>MM/LEF+MM/LEBS+MC-MQ/PLL+MM/4GA+N.2 MN-MY/PBPO+MC-MQ/LRPOA+N.2 MN-MY/F5LRP+MN-MY/F1BP</p> | <p>Cm 230x48x84 h - Mc 0,247 - Kgl 97,9 - N°6</p> <p><b>€ 3.054,00</b></p> |
| ANTE PER LIBRERIA<br>DOORS FOR BOOKCASE<br>PORTES POUR BIBLIOTHÈQUE<br>PUERTAS PARA BIBLIOTECA                                  |   | <p><b>MCN / LRPO</b><br/><b>MCY</b><br/><b>MQN</b><br/><b>MQY</b></p>                      | <p>ANTA A RIBALTA<br/>DROP-LEAF DOOR<br/>PORTE ABATTANTE<br/>PUERTA ABATIBLE</p> <p>MC-MQ/LRPOA+MN-MY/F5LRP</p>   | <p><b>MCN / LRPO / S</b><br/><b>MCY</b><br/><b>MQN</b><br/><b>MQY</b></p>   | <p>ANTA A RIBALTA CON SERRATURA PER:<br/>DROP-LEAF DOOR WITH LOCK FOR:<br/>PORTE ABATTANTE AVEC SERRURE POUR:<br/>PUERTA ABATIBLE CON CERRADURA PARA:<br/>M/LB-LBO</p> <p>MC-MQ/LRPOA/S+MN-MY/F5LRP/S</p>   | <p>Cm 133x42x1,9 h - Mc 0,033 - Kgl 15,9 - N°2</p> <p><b>€ 622,00</b></p>  |
|   | <p><b>MN / PBPO</b><br/><b>MY</b></p>                                  | <p>ANTA SINGOLA IN CUIO PER:<br/>SINGLE LEATHER DOOR FOR:<br/>PORTE SINGLE EN CUIR POUR:<br/>PUERTA SIMPLE DE CUERO PARA:<br/>M/LB-LBO</p> <p>MN-MY/PBPO+MN-MY/F5BP</p>       | <p><b>MN / PBPO / S</b><br/><b>MY</b></p>   | <p>ANTA SINGOLA IN CUIO CON SERRATURA<br/>SINGLE LEATHER DOOR WITH LOCK FOR:<br/>PORTE SINGLE EN CUIR AVEC SERRURE POUR:<br/>PUERTA SIMPLE DE CUERO CON CERRADURA PARA:<br/>M/LB-LBO</p> <p>MN-MY/PBPO/S+MN-MY/F5BP/S</p>                                     | <p>Cm 48x48x42 h - Mc 0,089 - Kgl 5,1 - N°2</p> <p><b>€ 636,00</b></p>  | <p>Cm 48x48x42 h - Mc 0,089 - Kgl 5,1 - N°2</p> <p><b>€ 781,00</b></p>     |

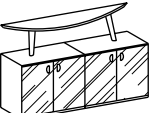
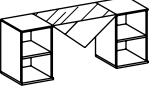
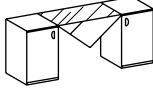
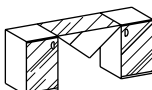
|   |  |   |  |   |  |
|---|--|---|--|---|--|
| LIBRERIE CON PIANO IN LEGNO<br>BOOKCASES WITH WOODEN TOP<br>BIBLIOTHÈQUES AVEC DESSUS EN BOIS<br>BIBLIOTECAS CON TAPA DE MADERA | <p><b>MCN / LC</b><br/><b>MCY</b><br/><b>MQN</b><br/><b>MQY</b></p>  <p>H76<br/>H68</p> | <p>CONSOLLE REGISTRABILE DA FISSARE AL MURO<br/>ADJUSTABLE CONSOLE TO FIX TO THE WALL<br/>CONSOLLE RÉGLABLE À FIXER AU MUR<br/>CONSOLA AJUSTABLE PARA FIJAR A LA PARED</p> <p>MN-MY/R2G+MC-MQ/PLLC</p>                                  |  |   |  |
|   | <p>Cm 180x35x68-76 h - Mc 0,125 - Kgl 18,0 - N°2</p>   | <p><b>€ 947,00</b></p>  |  |   |  |
|   | <p><b>MCN / LD/0</b><br/><b>MCY</b><br/><b>MQN</b><br/><b>MQY</b></p>                   | <p>LIBRERIA A GIORNO<br/>OPEN BOOKCASE<br/>BIBLIOTHÈQUE À CLAIR VOIE<br/>BIBLIOTECA SIN PUERTAS</p> <p>N.2 MM/FB+N.2 MM/SP1B+MC-MQ/PLLD+<br/>MC-MQ/PLLC+MM/COLD</p>   | <p><b>MCN / LD</b><br/><b>MCY</b><br/><b>MQN</b><br/><b>MQY</b></p>  | <p>LIBRERIA CON ANTE CIECHE<br/>BOOKCASE WITH STANDARD DOORS<br/>BIBLIOTHÈQUE AVEC PORTES PLEINES<br/>BIBLIOTECA CON PUERTAS LLENAS</p> <p>N.2 MM/FB+N.2 MM/SP1B+MC-MQ/PLLD+<br/>MC-MQ/PLLC+MM/COLD+<br/>N.2 MC-MQ/1BPOA+N.2 MN-MY/F1BP</p> |  |
|   | <p>Cm 180x48x113 h - Mc 0,389 - Kgl 87,7 - N°7</p>   | <p><b>€ 2.104,00</b></p>  | <p>Cm 180x48x113 h - Mc 0,431 - Kgl 104,3 - N°11</p>   | <p><b>€ 3.195,00</b></p>  |  |
|   | <p><b>MCN / LDV</b><br/><b>MCY</b><br/><b>MQN</b><br/><b>MQY</b></p>                    | <p>LIBRERIA CON ANTE VETRO<br/>BOOKCASE WITH GLASS DOORS<br/>BIBLIOTHÈQUE AVEC PORTES EN VERRE<br/>BIBLIOTECA CON PUERTAS DE VIDRIO</p> <p>N.2 MM/FB+N.2 MM/SP1B+MC-MQ/PLLD+<br/>MC-MQ/PLLC+MM/COLD+<br/>N.2 M/1BVTA+N.2 MN-MY/F1BV</p> |  |   |  |
|   | <p>Cm 180x48x113 h - Mc 0,441 - Kgl 104,1 - N°11</p>   | <p><b>€ 2.531,00</b></p>  |  |   |  |
| LIBRERIE CON PIANO IN VETRO<br>BOOKCASES WITH GLASS TOP<br>BIBLIOTHÈQUES AVEC DESSUS EN VERRE<br>BIBLIOTECAS CON TAPA DE VIDRIO | <p><b>MCN / LE/0</b><br/><b>MCY</b><br/><b>MQN</b><br/><b>MQY</b></p>                   | <p>LIBRERIA A GIORNO<br/>OPEN BOOKCASE<br/>BIBLIOTHÈQUE À CLAIR VOIE<br/>BIBLIOTECA SIN PUERTAS</p> <p>MM/FB+MM/FLE+N.2 MM/SP5B+<br/>N.2 MC-MQ/PL45+MM/SVLE+MN-MY/TRLE</p>  | <p><b>MCN / LE</b><br/><b>MCY</b><br/><b>MQN</b><br/><b>MQY</b></p>  | <p>LIBRERIA CON ANTE CIECHE<br/>BOOKCASE WITH STANDARD DOORS<br/>BIBLIOTHÈQUE AVEC PORTES PLEINES<br/>BIBLIOTECA CON PUERTAS LLENAS</p> <p>MM/FB+MM/FLE+N.2 MM/SP5B+<br/>N.2 MC-MQ/PL45+MN-MY/TRLE+<br/>MM/SVLE+MC-MQ/1BPOA+MN-MY/F1BP</p>  |  |
|   | <p>Cm 180x48x77 h - Mc 0,228 - Kgl 73,3 - N°8</p>  | <p><b>€ 1.427,00</b></p>  | <p>Cm 180x48x77 h - Mc 0,249 - Kgl 81,6 - N°10</p>   | <p><b>€ 1.972,00</b></p>  |  |
|   | <p><b>MCN / LEV</b><br/><b>MCY</b><br/><b>MQN</b><br/><b>MQY</b></p>                  | <p>LIBRERIA CON ANTE VETRO<br/>BOOKCASE WITH GLASS DOORS<br/>BIBLIOTHÈQUE AVEC PORTES EN VERRE<br/>BIBLIOTECA CON PUERTAS DE VIDRIO</p> <p>MM/FB+MM/FLE+N.2 MM/SP5B+<br/>N.2 MC-MQ/PL45+MM/SVLE+<br/>MN-MY/TRLE+M/1BVTA+MN-MY/F1BV</p>  |  |   |  |
|   | <p>Cm 180x48x77 h - Mc 0,254 - Kgl 81,5 - N°10</p>   | <p><b>€ 1.640,00</b></p>  |  |   |  |

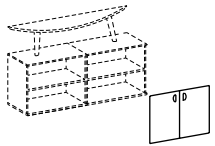
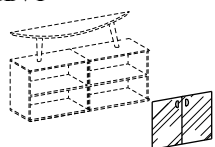
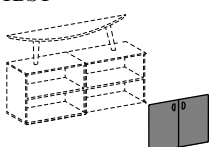
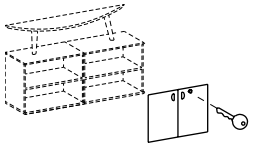
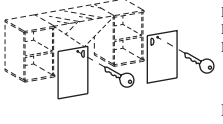
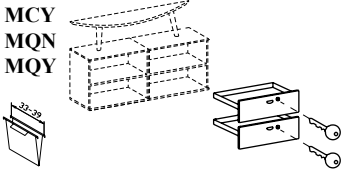
|  |   |  |  |  |
|--|---|--|--|--|
| <p style="writing-mode: vertical-rl; transform: rotate(180deg);"> <b>ANTE PER LIBRERIE</b><br/> <b>DOORS FOR BOOKCASES</b><br/> <b>PORTES POUR BIBLIOTHEQUES</b><br/> <b>PUERTAS PARA BIBLIOTECAS</b> </p>   | <p> <b>MCN / 1BPO</b><br/> <b>MCY</b><br/> <b>MQN</b><br/> <b>MQY</b> </p>  <p>                     COPPIA ANTE CIECHE PER:<br/>                     PAIR OF STANDARD DOORS FOR:<br/>                     COUPLE DE PORTES PLEINES POUR:<br/>                     PAR DE PUERTAS LLENAS PARA:<br/>                     M/LD/0-LE/0                 </p> <p>MC-MQ/1BPOA+MN-MY/F1BP</p>  |  |  |  |
|  | <p>Cm 90x1,9x77 h - Mc 0,021 - Kgl 8,3 - N°2</p> <p style="text-align: right;"><b>€ 546,00</b></p>  |  |  |  |
|  | <p> <b>MCN / 1BVT</b><br/> <b>MCY</b><br/> <b>MQN</b><br/> <b>MQY</b> </p>  <p>                     COPPIA ANTE VETRO PER:<br/>                     PAIR OF GLASS DOORS FOR:<br/>                     COUPLE DE PORTES EN VERRE POUR:<br/>                     PAR DE PUERTAS DE VIDRIO PARA:<br/>                     M/LD/0-LE/0                 </p> <p>M/1BVTa+MN-MY/F1BV</p>  | <p> <b>MCN / 1BST</b><br/> <b>MCY</b><br/> <b>MQN</b><br/> <b>MQY</b> </p>  <p>                     COPPIA ANTE VETRO SATINATO PER:<br/>                     PAIR OF SATIN GLASS DOORS FOR:<br/>                     COUPLE DE PORTES EN VERRE SATINÉ POUR:<br/>                     PAR DE PUERTAS DE VIDRIO SATINADO PARA:<br/>                     M/LD/0-LE/0                 </p> <p>M/1BSTa+MN-MY/F1BV</p>   |  |  |
| <p>Cm 90x0,5x77 h - Mc 0,026 - Kgl 8,2 - N°2</p> <p style="text-align: right;"><b>€ 214,00</b></p>   | <p>Cm 90x0,5x77 h - Mc 0,026 - Kgl 8,2 - N°2</p> <p style="text-align: right;"><b>€ 259,00</b></p>  |  |  |  |
| <p style="writing-mode: vertical-rl; transform: rotate(180deg);"> <b>ANTE CIECHE CON SERRATURA PER LIBRERIE</b><br/> <b>STANDARD DOORS WITH LOCK FOR BOOKCASES</b><br/> <b>PORTES PLEINES AVEC SERRURE POUR BIBLIOTHEQUES</b><br/> <b>PUERTAS LLENAS CON CERRADURA PARA BIBLIOTECAS</b> </p> | <p> <b>MCN / 1BPO/S</b><br/> <b>MCY</b><br/> <b>MQN</b><br/> <b>MQY</b> </p>  <p>                     COPPIA ANTE CIECHE CON SERRATURA PER:<br/>                     PAIR OF STANDARD DOORS WITH LOCK FOR:<br/>                     COUPLE DE PORTES PLEINES AVEC SERRURE<br/>                     POUR:<br/>                     PAR DE PUERTAS LLENAS CON CERRADURA<br/>                     PARA:<br/>                     M/LD/0                 </p> <p>MC-MQ/1BPOA/S+MN-MY/F1BP/S</p>          | <p> <b>MCN / 1BPO/2S</b><br/> <b>MCY</b><br/> <b>MQN</b><br/> <b>MQY</b> </p>  <p>                     COPPIA ANTE SINGOLE CIECHE CON SERRATURA PER:<br/>                     PAIR OF SINGLE STANDARD DOORS WITH LOCK FOR:<br/>                     COUPLE DE PORTES PLEINES SINGLE+ SERRURE POUR:<br/>                     PAR DE PUERTAS SIMPLES LLENAS+CERRADURA<br/>                     PARA:<br/>                     M/LE/0                 </p> <p>MC-MQ/1BPOA/2S+N.2 MN-MY/F5BP/S</p> |  |  |
|  | <p>Cm 90x1,9x77 h - Mc 0,021 - Kgl 8,3 - N°2</p> <p style="text-align: right;"><b>€ 659,00</b></p>  | <p>Cm 45+45x1,9x77 h - Mc 0,021 - Kgl 8,3 - N°3</p> <p style="text-align: right;"><b>€ 698,00</b></p>  |  |  |
|  | <p> <b>MCN / 1CSC/S</b><br/> <b>MCY</b><br/> <b>MQN</b><br/> <b>MQY</b> </p>  <p>                     COPPIA CASSETTI SCHEDARI CON SERRATURA PER:<br/>                     PAIR OF FILING DRAWERS WITH LOCK FOR:<br/>                     COUPLE DE TIROIRS FICHER AVEC SERRURE<br/>                     POUR:<br/>                     PAR DE CAJONES FICHERO CON CERRADURA<br/>                     PARA:<br/>                     M/LD/0                 </p> <p>MC-MQ/1CSCA/S+MN-MY/F1CS/S</p> |  |  |  |
| <p>Cm 90x48x77 h - Mc 0,100 - Kgl 20,3 - N°2</p> <p style="text-align: right;"><b>€ 965,00</b></p>   |   |  |  |  |
|  |   |  |  |  |
|  |   |  |  |  |
|  |   |  |  |  |
|  |   |  |  |  |
|  |   |  |  |  |
|  |   |  |  |  |

**PER MOTIVI DI SICUREZZA TUTTI GLI ARMADI CHE ALLOGGIANO CASSETTI SCHEDARIO: NEL CASO DI MULTIPLI ADIACENTI VANNO FISSATI TRA LORO PER MEZZO DELLE VITI IN DOTAZIONE**

FOR SAFETY REASONS ALL THE CABINETS EQUIPPED WITH FILING DRAWERS: MUST BE FIXED EACH OTHER WITH THE SUPPLIED SCREWS IN CASE OF ADJOINING MULTIPLE UNITS

POUR RAISONS DE SÉCURITÉ TOUTES LES ARMOIRES DOTÉES DE TIROIRS FICHER: DOIVENT ÊTRE FIXÉS ENTRE EUX AVEC LES VIS FOURNIES EN CAS DE MULTIPLES ADJACENTS

POR RAZONES DE SEGURIDAD, TODOS LOS ARMARIOS QUE ALOJAN CAJONES FICHEROS: DEBEN SER FIJADOS ENTRE SÍ USANDO LOS TORNILLOS ENTREGADOS CON LOS EQUIPOS EN EL CASO DE MÚLTIPLES ADYACENTES

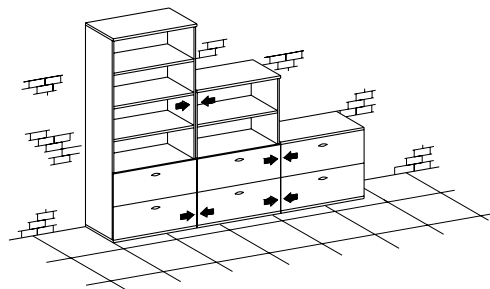

**NEL CASO DI ELEMENTO SINGOLO, QUESTO DEVE VENIRE ASSICURATO A UNA PARETE DI SOSTEGNO**

MUST BE SECURED TO A SUPPORTING WALL IN CASE OF A SINGLE UNIT.

DOIVENT ÊTRE ASSURÉES À UNE CLOISON DE SUPPORT EN CAS DE ÉLÉMENT SIMPLE.

DEBEN SER FIJADOS A UNA PARED DE SOSTÉN SI SE USAN DE FORMA INDIVIDUAL.

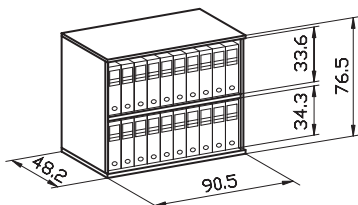
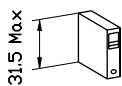
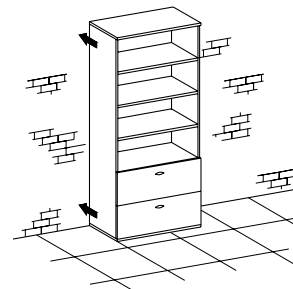

**LA CAPACITÀ STANDARD È DI 2 FILE DI RACCOGLITORI**

THE STANDARD CAPACITY ALLOWS TO PLACE 2 ROWS OF FILE-COVERS

LA CAPACITÉ STANDARD EST DE 2 SUITES DE CLASSEURS

LA CAPACIDAD ESTANDAR ES DE 2 RINGLERAS DE ARCHIVADORES

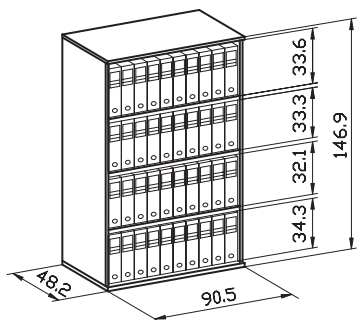

**LA CAPACITÀ STANDARD È DI 4 FILE DI RACCOGLITORI.**

THE STANDARD CAPACITY ALLOWS TO PLACE 4 ROWS OF FILE-COVERS.

LA CAPACITÉ STANDARD EST DE 4 SUITES DE CLASSEURS.

LA CAPACIDAD ESTANDAR ES DE 4 RINGLERAS DE ARCHIVADORES.

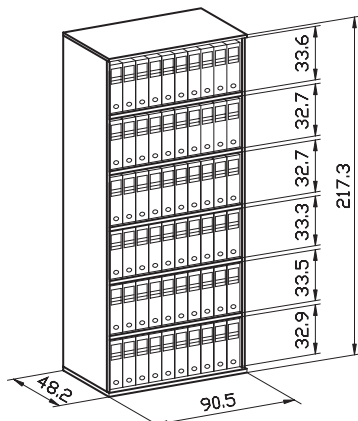

**LA CAPACITÀ STANDARD È DI 6 FILE DI RACCOGLITORI.**





THE STANDARD CAPACITY ALLOWS TO PLACE 6 ROWS OF FILE-COVERS.

LA CAPACITÉ STANDARD EST DE 6 SUITES DE CLASSEURS.

LA CAPACIDAD ESTANDAR ES DE 6 RINGLERAS DE ARCHIVADORES.

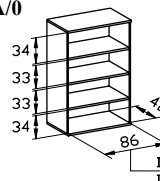
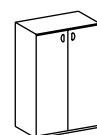
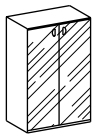
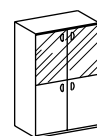

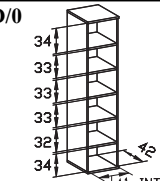
|   |  |   |  |  |  |
|---|--|---|--|--|--|
| ARMADI CON FIANCHIE E TRIPIANO IN METALLO<br>CABINETS WITH METAL SIDES AND 1 METAL SHELF<br>ARMOIRES AVEC COTES ET 1 ETAGERE EN METAL<br>ARMARIOS CON COSTADOS Y 1 ESTANTE EN METAL     | MCN / 5B/0<br>MCY<br>MQN<br>MQY<br>        | ARMADIO A GIORNO<br>OPEN CABINET<br>ARMOIRE À CLAIRE VOIE<br>ARMARIO SIN PUERTAS<br><br>MM/FB+MM/SP5B+MC-MQ/PL45  | MCN / 5B/1<br>MCY<br>MQN<br>MQY<br>        | ARMADIO CON ANTA CIECA<br>CABINET WITH STANDARD DOOR<br>ARMOIRE AVEC PORTE PLEINE<br>ARMARIO CON PUERTA LLENA<br><br>MM/FB+MM/SP5B+MC-MQ/PL45+<br>MC-MQ/5BPOA+MN-MY/F5BP   |  |
|   | Cm 45x48x77 h - Mc 0,104 - Kgl 26,2 - N°3  | <b>€ 547,00</b>   | Cm 45x48x77 h - Mc 0,124 - Kgl 30,7 - N°5  | <b>€ 847,00</b>  |  |
|   | MCN / 5B/3<br>MCY<br>MQN<br>MQY<br>        | ARMADIO CON ANTA VETRO<br>CABINET WITH GLASS DOOR<br>ARMOIRE AVEC PORTE EN VERRE<br>ARMARIO CON PUERTA DE VIDRIO<br><br>MM/FB+MM/SP5B+MC-MQ/PL45+<br>M/5BVTA+MN-MY/F5BV   |  |  |  |
|   | Cm 45x48x77 h - Mc 0,130 - Kgl 30,9 - N°5  | <b>€ 682,00</b>   |  |  |  |
|   | MCN / AB<br>MCY<br>MQN<br>MQY<br>          | LIBRERIA ANGOLARE CON ANTA CIECA<br>ANGULAR BOOKCASE WITH STANDARD DOOR<br>BIBLIOTHÈQUE ANGULAIRE AVEC PORTE PLEINE<br>BIBLIOTECA ESQUINERA CON PUERTA LLENA<br><br>MM/FAB+MC-MQ/PLAB+MN-MY/ABPOA+<br>MN-MY/FABP  |  |  |  |
| Cm 48x48x77 h - Mc 0,220 - Kgl 27,8 - N°4   | <b>€ 1.304,00</b>                          |   |  |  |  |
| ARMADI CON FIANCHIE E 3 RIPIANI METALLICI<br>CABINETS WITH METAL SIDES AND 3 METAL SHELVES<br>ARMOIRES AVEC COTES ET 3 ETAGERES EN METAL<br>ARMARIOS CON COSTADOS Y 3 ESTANTES EN METAL | MCN / 1B/0<br>MCY<br>MQN<br>MQY<br>        | ARMADIO A GIORNO<br>OPEN CABINET<br>ARMOIRE À CLAIRE VOIE<br>ARMARIO SIN PUERTAS<br><br>MM/FB+MM/SP1B+MC-MQ/PL90  | MCN / 1B/1<br>MCY<br>MQN<br>MQY<br>        | ARMADIO CON ANTE CIECHE<br>CABINET WITH STANDARD DOORS<br>ARMOIRE AVEC PORTES PLEINES<br>ARMARIO CON PUERTAS LLENAS<br><br>MM/FB+MM/SP1B+MC-MQ/PL90+<br>MC-MQ/1BPOA+MN-MY/F1BP   |  |
|   | Cm 90x48x77 h - Mc 0,176 - Kgl 36,3 - N°3  | <b>€ 701,00</b>   | Cm 90x48x77 h - Mc 0,197 - Kgl 44,6 - N°5  | <b>€ 1.246,00</b>  |  |
|   | MCN / 1B/2<br>MCY<br>MQN<br>MQY<br>        | ARMADIO CON SCHEDARI<br>CABINET WITH FILING DRAWERS<br>ARMOIRE AVEC FICHIERS<br>ARMARIO CON FICHEROS<br><br>MM/FB+MM/SP1B+MC-MQ/PL90+<br>MC-MQ/1CSCA+MN-MY/F1CS   | MCN / 1B/3<br>MCY<br>MQN<br>MQY<br>        | ARMADIO CON ANTE VETRO<br>CABINET WITH GLASS DOORS<br>ARMOIRE AVEC PORTES EN VERRE<br>ARMARIO CON PUERTAS DE VIDRIO<br><br>MM/FB+MM/SP1B+MC-MQ/PL90+<br>M/1BVTA+MN-MY/F1BV   |  |
|   | Cm 90x48x77 h - Mc 0,276 - Kgl 56,6 - N°5  | <b>€ 1.510,00</b>   | Cm 90x48x77 h - Mc 0,202 - Kgl 44,5 - N°5  | <b>€ 914,00</b>  |  |
|   |  |   |  |  |  |
| ARMADI CON FIANCHIE E 3 RIPIANI METALLICI<br>CABINETS WITH METAL SIDES AND 3 METAL SHELVES<br>ARMOIRES AVEC COTES ET 3 ETAGERES EN METAL<br>ARMARIOS CON COSTADOS Y 3 ESTANTES EN METAL | MCN / 5A/0<br>MCY<br>MQN<br>MQY<br>        | ARMADIO A GIORNO<br>OPEN CABINET<br>ARMOIRE À CLAIRE VOIE<br>ARMARIO SIN PUERTAS<br><br>MM/FA+MM/SP5A+MC-MQ/PL45  | MCN / 5A/1<br>MCY<br>MQN<br>MQY<br>        | ARMADIO CON ANTA CIECHE<br>CABINET WITH STANDARD DOOR<br>ARMOIRE AVEC PORTE PLEINE<br>ARMARIO CON PUERTAS LLENA<br><br>MM/FA+MM/SP5A+MC-MQ/PL45+<br>MC-MQ/5APOA+MN-MY/F5BP   |  |
|   | Cm 45x48x147 h - Mc 0,162 - Kgl 46,6 - N°3 | <b>€ 763,00</b>   | Cm 45x48x147 h - Mc 0,204 - Kgl 55,8 - N°5 | <b>€ 1.221,00</b>  |  |
|   | MCN / 5A/2<br>MCY<br>MQN<br>MQY<br>        | ARMADIO CON ANTA VETRO<br>CABINET WITH GLASS DOORS<br>ARMOIRE AVEC PORTES EN VERRE<br>ARMARIO CON PUERTAS DE VIDRIO<br><br>MM/FA+MM/SP5A+MC-MQ/PL45+<br>M/5AVTA+MN-MY/F5BV  | MCN / 5A/3<br>MCY<br>MQN<br>MQY<br>        | ARMADIO CON ANTE CIECHE E VETRO<br>CABINET WITH STANDARD AND GLASS DOORS<br>ARMOIRE AVEC PORTES PLEINES ET EN VERRE<br>ARMARIO CON PUERTAS LLENAS Y DE VIDRIO<br><br>MM/FA+MM/SP5A+MC-MQ/PL45+<br>MC-MQ/5BPOA+ M/5BVTA+<br>MN-MY/F1BP+MN-MY/F1BV |  |
|   | Cm 45x48x147 h - Mc 0,212 - Kgl 56,1 - N°5 | <b>€ 937,00</b>   | Cm 45x48x147 h - Mc 0,208 - Kgl 55,8 - N°7 | <b>€ 1.198,00</b>  |  |
|   | MCN / AA<br>MCY<br>MQN<br>MQY<br>          | LIBRERIA ANGOLARE A GIORNO CON ANTA CIECA<br>ANGULAR OPEN BOOKCASE WITH STANDARD DOOR<br>BIBLIOTHÈQUE À CLAIRE VOIE AVEC PORTE PLEINE<br>BIBLIOTECA ESQUINERA SIN PUERTAS Y PUERTA LLENA<br><br>MM/FAA+MC-MQ/PLAB+MC-MQ/PLAA+<br>MN-MY/ABPOA+MN-MY/FABP |  |  |  |
| Cm 48x48x147 h - Mc 0,270 - Kgl 44,8 - N°5  | <b>€ 1.735,00</b>                          |   |  |  |  |

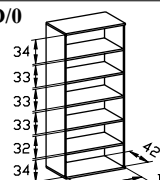
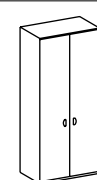
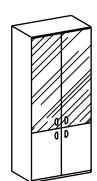
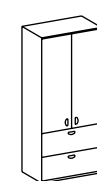
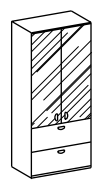
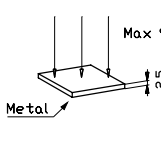
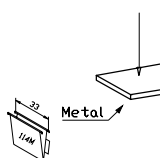
|  |  |   |   |  |
|--|--|---|---|--|
| ARMADI CON FIANCHI E 3 RIPIANI METALLICI<br>CABINETS WITH METAL SIDES AND 3 METAL SHELVES<br>ARMOIRES AVEC COTES ET 3 ÉTAGÈRES EN MÉTAL<br>ARMARIOS CON COSTADOS Y 3 ESTANTES EN METAL | <b>MCN / 1A/0</b><br><b>MCY</b><br><b>MQN</b><br><b>MQY</b>  |  <p>ARMADIO A GIORNO<br/>OPEN CABINET<br/>ARMOIRE À CLAIRE VOIE<br/>ARMARIO SIN PUERTAS</p>  | <b>MCN / 1A/1</b><br><b>MCY</b><br><b>MQN</b><br><b>MQY</b>   |  <p>ARMADIO CON ANTE CIECHE<br/>CABINET WITH STANDARD DOORS<br/>ARMOIRE AVEC PORTES PLEINES<br/>ARMARIO CON PUERTAS LLENAS</p>   |
|  | Cm 90x48x147 h - Mc 0,225 - Kgl 62,3 - N°3   | € 943,00  | Cm 90x48x147 h - Mc 0,269 - Kgl 78,6 - N°5  | € 1.793,00   |
|  | <b>MCN / 1A/2</b><br><b>MCY</b><br><b>MQN</b><br><b>MQY</b>  |  <p>ARMADIO CON ANTE VETRO<br/>CABINET WITH GLASS DOORS<br/>ARMOIRE AVEC PORTES EN VERRE<br/>ARMARIO CON PUERTAS DE VIDRIO</p>   | <b>MCN / 1A/3</b><br><b>MCY</b><br><b>MQN</b><br><b>MQY</b>   |  <p>ARMADIO CON ANTE CIECHE E VETRO<br/>CABINET WITH STANDARD DOORS AND GLASS DOORS<br/>ARMOIRE AVEC PORTES PLEINES ET EN VERRE<br/>ARMARIO CON PUERTAS LLENAS Y DE VIDRIO</p> |
|  | Cm 90x48x147 h - Mc 0,275 - Kgl 78,3 - N°5   | € 1.223,0   | Cm 90x48x147 h - Mc 0,272 - Kgl 78,8 - N°7  | € 1.701,00   |
|  | <b>MCN / 1A/5</b><br><b>MCY</b><br><b>MQN</b><br><b>MQY</b>  |  <p>ARMADIO CON ANTE VETRO+SCHEDARI<br/>CABINET WITH GLASS DOORS+FILING DRAWERS<br/>ARMOIRE AVEC PORTES EN VERRE+FICHIERS<br/>ARMARIOS CON PUERTAS DE VIDRIO+FICHEROS</p>  |   |  |
| Cm 90x48x147 h - Mc 0,351 - Kgl 90,8 - N°7   | € 1.965,00   |   |   |  |
| ARMADI CON FIANCHI E 5 RIPIANI METALLICI<br>CABINETS WITH METAL SIDES AND 5 METAL SHELVES<br>ARMOIRES AVEC COTES ET 5 ÉTAGÈRES EN MÉTAL<br>ARMARIOS CON COSTADOS Y 5 ESTANTES EN METAL | <b>MCN / 5D/0</b><br><b>MCY</b><br><b>MQN</b><br><b>MQY</b>  |  <p>ARMADIO A GIORNO<br/>OPEN CABINET<br/>ARMOIRE À CLAIRE VOIE<br/>ARMARIO SIN PUERTAS</p>  | <b>MCN / 5D/1</b><br><b>MCY</b><br><b>MQN</b><br><b>MQY</b>   |  <p>ARMADIO CON ANTA CIECA<br/>CABINET WITH STANDARD DOOR<br/>ARMOIRE AVEC PORTE PLEINE<br/>ARMARIO CON PUERTA LLENA</p>  |
|  | Cm 45x48x217 h - Mc 0,146 - Kgl 59,1 - N°2   | € 792,00  | Cm 45x48x217 h - Mc 0,203 - Kgl 74,4 - N°4  | € 1.434,0  |
|  | <b>MCN / 5D/2</b><br><b>MCY</b><br><b>MQN</b><br><b>MQY</b>  |  <p>ARMADIO CON ANTE CIECHE E VETRO<br/>CABINET WITH STANDARD AND GLASS DOORS<br/>ARMOIRE AVEC PORTES PLEINES ET EN VERRE<br/>ARMARIO CON PUERTAS LLENAS Y DE VIDRIO</p> |   |  |
|  | Cm 45x48x217 h - Mc 0,216 - Kgl 73,1 - N°6   | € 1.266,0   |   |  |
|  | <b>MCN / 1D/0</b><br><b>MCY</b><br><b>MQN</b><br><b>MQY</b>  |  <p>ARMADIO A GIORNO<br/>OPEN CABINET<br/>ARMOIRE À CLAIRE VOIE<br/>ARMARIO SIN PUERTAS</p>  | <b>MCN / 1D/1</b><br><b>MCY</b><br><b>MQN</b><br><b>MQY</b>   |  <p>ARMADIO CON ANTE CIECHE<br/>CABINET WITH STANDARD DOORS<br/>ARMOIRE AVEC PORTES PLEINES<br/>ARMARIO CON PUERTAS LLENAS</p>   |
| Cm 90x48x217 h - Mc 0,243 - Kgl 80,4 - N°2   | € 876,00   | Cm 90x48x217 h - Mc 0,303 - Kgl 108,1 - N°4   | € 2.090,00  |  |
| <b>MCN / 1D/2</b><br><b>MCY</b><br><b>MQN</b><br><b>MQY</b>  |  <p>ARMADIO CON ANTE CIECHE E VETRO<br/>CABINET WITH STANDARD AND GLASS DOORS<br/>ARMOIRE AVEC PORTES PLEINES ET EN VERRE<br/>ARMARIO CON PUERTAS LLENAS Y DE VIDRIO</p>  | <b>MCN / 1D/3</b><br><b>MCY</b><br><b>MQN</b><br><b>MQY</b>   |  <p>ARMADIO CON ANTE CIECHE E SCHEDARI<br/>CABINET WITH STANDARD DOORS AND FILING DRAWERS<br/>ARMOIRE AVEC PORTES PLEINES ET FICHIERS<br/>ARMARIOS CON PUERTAS LLENAS Y FICHEROS</p>                                      |  |
| Cm 90x48x217 h - Mc 0,314 - Kgl 104,7 - N°6  | € 1.701,00   | Cm 90x48x217 h - Mc 0,387 - Kgl 117,0 - N°6   | € 2.535,00  |  |
| <b>MCN / 1D/5</b><br><b>MCY</b><br><b>MQN</b><br><b>MQY</b>  |  <p>ARMADIO CON ANTE VETRO+SCHEDARI<br/>CABINET WITH GLASS DOORS+FILING DRAWERS<br/>ARMOIRE AVEC PORTES EN VERRE+FICHIERS<br/>ARMARIOS CON PUERTAS DE VIDRIO+FICHEROS</p>   |   |   |  |
| Cm 90x48x217 h - Mc 0,393 - Kgl 116,7 - N°6  | € 1.965,00   |   |   |  |
| <b>MM / INT45</b>  |  <p>RIPIANO METALLICO PER ARMADI CON FIANCHI IN METALLO<br/>METAL SHELF FOR CABINETS WITH METAL SIDES<br/>ÉTAGÈRE EN MÉTAL POUR ARMOIRES AVEC COTES EN METAL<br/>ESTANTE METÁLICO PARA ARMARIOS CON COSTADOS EN METAL</p> | <b>MM / INT90</b>   |  <p>RIPIANO METALLICO PER ARMADI CON FIANCHI IN METALLO<br/>METAL SHELF FOR CABINETS WITH METAL SIDES<br/>ÉTAGÈRE EN MÉTAL POUR ARMOIRES AVEC COTES EN METAL<br/>ESTANTE METÁLICO PARA ARMARIOS CON COSTADOS EN METAL</p> |  |
| Cm 45x48x2,5 h - Mc 0,007 - Kgl 1,7 - N°1  | € 74,00  | Cm 90x48x2,5 h - Mc 0,015 - Kgl 3,5 - N°1   | € 79,00   |  |

**ARMADI CON STRUTTURA IN NOBILITATO MELAMINICO E RIPIANI METALLICI**  
**CABINETS WITH MELAMINE-FACED STRUCTURE AND METAL SHELVES**  
**ARMOIRES AVEC STRUCTURE EN PANNEAUX MÉLAMINÉS ET ÉTAGÈRES MÉTALLIQUES**  
**ARMARIOS CON ESTRUCTURA EN TABLERO MELAMINADO Y ESTANTES METÁLICOS**

**PER LE CONFIGURAZIONI COMPLETE UTILIZZARE LE PORTE E I CASSETTI DI PAG. 21-22**  
**FOR THE COMPLETE COMPOSITIONS USE THE DOORS AND DRAWERS REPORTED ON PAGE 21-22**  
**POUR LES COMPOSITIONS COMPLÈTES UTILISER LES PORTES ET LES TIROIRS DE PAGE 21-22**  
**PARA LAS CONFIGURACIONES COMPLETAS USAR LAS PUERTAS Y LOS CAJONES DE PÁG. 21-22**

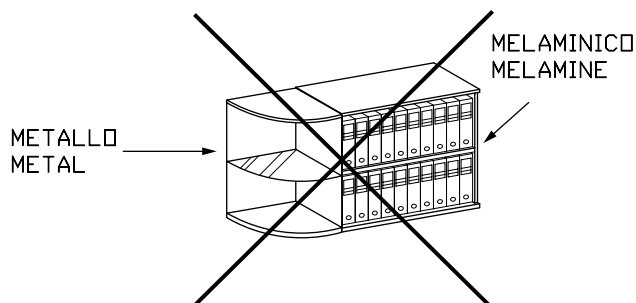

**NON E' POSSIBILE COLLEGARE GLI ARMADI MELAMINICI CON LE ANGOLIERE METALLICHE DI PAG. 14 E 18**  
**IT IS NOT POSSIBLE TO CONNECT THE MELAMINE CABINETS WITH THE METAL CORNER UNITS REPORTED ON PAGE 14 E 18**  
**IL N'EST PAS POSSIBLE DE JOINDRE LES ARMOIRES MÉLAMINÉES AVEC LES ÉLÉMENTS ANGULAIRES MÉTALLIQUES DE PAGE 14 E 18**  
**NO ES POSIBLE UNIR LOS ARMARIOS MELAMÍNICOS CON LAS RINCONERAS METÁLICAS DE PÁG. 14 E 18**

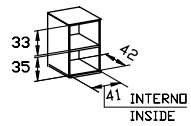
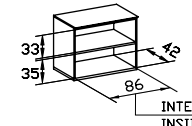
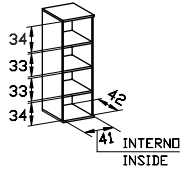
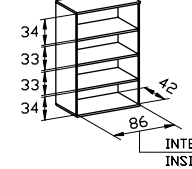
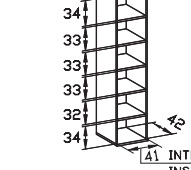
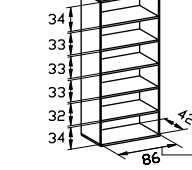
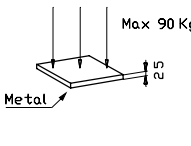
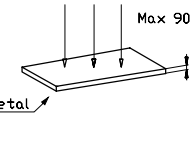

ARMADI CON STRUTTURA IN NOBILITATO MELAMINICO E RIPIANI METALLICI  
 CABINETS WITH STRUCTURE IN MELAMINE WITH WOOD EFFECT AND METAL SHELVES  
 ARMOIRES AVEC STRUCTURE EN MELAMINE DÉCOR BOIS ET ÉTAGÈRES MÉTALLIQUES  
 ARMARIOS CON ESTRUCTURA EN TABLERO RECHAPADO MELAMINICO Y ESTANTES METÁLICOS

|  |   |   |   |
|--|---|---|---|
| <p><b>MCN / 5B/0CE</b><br/> <b>MCY</b><br/> <b>MQN</b><br/> <b>MQY</b></p>  <p>Cm 45x48x77 h - Mc 0,068 - Kgl 24,5 - N°2</p>  | <p>ARMADIO MELAMINICO A GIORNO<br/>                 OPEN MELAMINE CABINET<br/>                 ARMOIRE À CLAIRE VOIE EN MÉLAMINÉ<br/>                 ARMARIO MELAMÍNICO SIN PUERTAS</p> <p>CM/5FSRB/M+MC-MQ/PL45/CE</p> <p align="center"><b>€ 360,00</b></p>                          | <p><b>MCN / 1B/0CE</b><br/> <b>MCY</b><br/> <b>MQN</b><br/> <b>MQY</b></p>  <p>Cm 90x48x77 h - Mc 0,123 - Kgl 36,5 - N°2</p>  | <p>ARMADIO MELAMINICO A GIORNO<br/>                 OPEN MELAMINE CABINET<br/>                 ARMOIRE À CLAIRE VOIE EN MÉLAMINÉ<br/>                 ARMARIO MELAMÍNICO SIN PUERTAS</p> <p>CM/1FSRB/M+MC-MQ/PL90/CE</p> <p align="center"><b>€ 608,00</b></p>                          |
| <p><b>MCN / 5A/0CE</b><br/> <b>MCY</b><br/> <b>MQN</b><br/> <b>MQY</b></p>  <p>Cm 45x78x147 h - Mc 0,113 - Kgl 38,8 - N°2</p> | <p>ARMADIO MELAMINICO A GIORNO<br/>                 OPEN MELAMINE CABINET<br/>                 ARMOIRE À CLAIRE VOIE EN MÉLAMINÉ<br/>                 ARMARIO MELAMÍNICO SIN PUERTAS</p> <p>CM/D5FSRA/M+MC-MQ/PL45/CE</p> <p align="center"><b>€ 448,00</b></p>                         | <p><b>MCN / 1A/0CE</b><br/> <b>MCY</b><br/> <b>MQN</b><br/> <b>MQY</b></p>  <p>Cm 90x48x147 h - Mc 0,266 - Kgl 58,2 - N°3</p> | <p>ARMADIO MELAMINICO A GIORNO<br/>                 OPEN MELAMINE CABINET<br/>                 ARMOIRE À CLAIRE VOIE EN MÉLAMINÉ<br/>                 ARMARIO MELAMÍNICO SIN PUERTAS</p> <p>CM/1FSA+CM/D1SRA/M+MC-MQ/PL90/CE</p> <p align="center"><b>€ 772,00</b></p>                  |
| <p><b>MCN / 5D/0CE</b><br/> <b>MCY</b><br/> <b>MQN</b><br/> <b>MQY</b></p>  <p>Cm 45x47x217 h - Mc 0,120 - Kgl 53,9 - N°2</p> | <p>ARMADIO MELAMINICO A GIORNO<br/>                 OPEN MELAMINE CABINET<br/>                 ARMOIRE À CLAIRE VOIE EN MÉLAMINÉ<br/>                 ARMARIO MELAMÍNICO SIN PUERTAS</p> <p>CM/D5RTSD/M+CM/5RTSD</p> <p align="center"><b>€ 492,00</b></p>                              | <p><b>MCN / 1D/0CE</b><br/> <b>MCY</b><br/> <b>MQN</b><br/> <b>MQY</b></p>  <p>Cm 90x48x217 h - Mc 0,306 - Kgl 83,9 - N°3</p> | <p>ARMADIO MELAMINICO A GIORNO<br/>                 OPEN MELAMINE CABINET<br/>                 ARMOIRE À CLAIRE VOIE EN MÉLAMINÉ<br/>                 ARMARIO MELAMÍNICO SIN PUERTAS</p> <p>CM/1FSD+CM/D1SRA/M+CM/1TRD/M</p> <p align="center"><b>€ 669,00</b></p>                      |
| <p><b>CM / 5RB/M</b></p>  <p>Cm 45x47x2,5 h - Mc 0,009 - Kgl 3,6 - N°1</p>  | <p>RIPIANO METALLICO PER ARMADIO MELAMINICO<br/>                 METAL SHELF FOR MELAMINE CABINET<br/>                 ÉTAGÈRE EN MÉTAL POUR ARMOIRE EN MÉLAMINÉ<br/>                 ESTANTE METÁLICO PARA ARMARIO MELAMÍNICO</p> <p>CM/5RB/M</p> <p align="center"><b>€ 45,00</b></p> | <p><b>CM / 1RB/M</b></p>  <p>Cm 90x47x2,5 h - Mc 0,022 - Kgl 7,2 - N°1</p>  | <p>RIPIANO METALLICO PER ARMADIO MELAMINICO<br/>                 METAL SHELF FOR MELAMINE CABINET<br/>                 ÉTAGÈRE EN MÉTAL POUR ARMOIRE EN MÉLAMINÉ<br/>                 ESTANTE METÁLICO PARA ARMARIO MELAMÍNICO</p> <p>CM/1RB/M</p> <p align="center"><b>€ 51,00</b></p> |

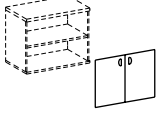
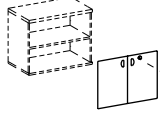
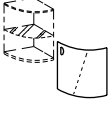
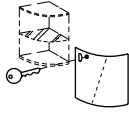
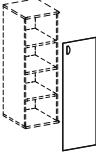
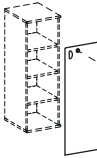
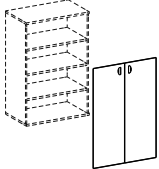
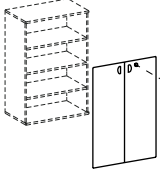
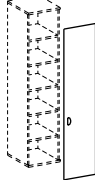
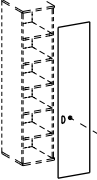
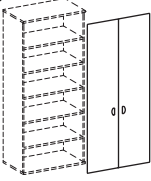
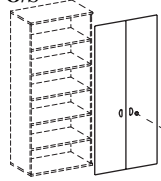

|  |   |   |   |                        |   |   |  |                            |   |                  |   |                  |
|--|---|---|---|------------------------|---|---|--|----------------------------|---|------------------|---|------------------|
| ANTE PER ARMADI<br>DOORS FOR CABINETS<br>PORTES POUR ARMOIRES<br>PUERTAS PARA ARMARIOS | <b>MCN / 5BPO</b><br><b>MCY</b><br><b>MQN</b><br><b>MQY</b> |    | ANTA SINGOLA CIECA PER:<br>SINGLE STANDARD DOOR FOR:<br>PORTE PLEINE SINGLE POUR:<br>PUERTA SIMPLE LLENA PARA:<br>M/5B/0-5D/0               | MC-MQ/5BPOA+MN-MY/F5BP | <b>MCN / 5BPO/S</b><br><b>MCY</b><br><b>MQN</b><br><b>MQY</b> |     | ANTA SINGOLA CIECA CON SERRATURA PER:<br>SINGLE STANDARD DOOR WITH LOCK FOR:<br>PORTE PLEINE SINGLE AVEC SERRURE POUR:<br>PUERTA SIMPLE LLENA CON CERRADURA PARA:<br>M/5B/0-5D/0               | MC-MQ/5BPOA/S+MN-MY/F5BP/S | Cm 45x1,9x77 h - Mc 0,020 - Kgl 4,5 - N°2   | <b>€ 301,00</b>  | Cm 45x1,9x77 h - Mc 0,020 - Kgl 4,5 - N°2   | <b>€ 414,00</b>  |
|  | <b>MCN / 1BPO</b><br><b>MCY</b><br><b>MQN</b><br><b>MQY</b> |    | COPPIA ANTE CIECHE PER:<br>PAIR OF STANDARD DOORS FOR:<br>COUPLE DE PORTES PLEINES POUR:<br>PAR DE PUERTAS LLENAS PARA:<br>M/1B/0-1A/0-1D/0 | MC-MQ/1BPOA+MN-MY/F1BP | <b>MCN / 1BPO/S</b><br><b>MCY</b><br><b>MQN</b><br><b>MQY</b> |     | COPPIA ANTE CIECHE CON SERRATURA PER:<br>PAIR OF STANDARD DOORS WITH LOCK FOR:<br>COUPLE DE PORTES PLEINES AVEC SERRURE POUR:<br>PAR DE PUERTAS LLENAS CON CERRADURA PARA:<br>M/1B/0-1A/0-1D/0 | MC-MQ/1BPOA/S+MN-MY/F1BP/S | Cm 90x1,9x77 h - Mc 0,021 - Kgl 8,3 - N°2   | <b>€ 546,00</b>  | Cm 90x1,9x77 h - Mc 0,021 - Kgl 8,3 - N°2   | <b>€ 659,00</b>  |
|  | <b>MN / ABPO</b><br><b>MY</b>                               |    | ANTA SINGOLA CIECA PER:<br>SINGLE STANDARD DOOR FOR:<br>PORTE PLEINE SINGLE POUR:<br>PUERTA SIMPLE LLENA PARA:<br>M/AB/0-AA/0               | MN-MY/ABPOA+MN-MY/FABP | <b>MN / ABPO/S</b><br><b>MY</b>                               |     | ANTA SINGOLA CIECA CON SERRATURA PER:<br>SINGLE STANDARD DOOR WITH LOCK FOR:<br>PORTE PLEINE SINGLE AVEC SERRURE POUR:<br>PUERTA SIMPLE LLENA CON CERRADURA PARA:<br>M/AB/0-AA/0               | MN-MY/ABPOA/S+MN-MY/FABP/S | Cm 48x1,9x77 h - Mc 0,163 - Kgl 8,0 - N°2   | <b>€ 646,00</b>  | Cm 48x1,9x77 h - Mc 0,163 - Kgl 8,0 - N°2   | <b>€ 791,00</b>  |
|  | <b>MCN / 5APO</b><br><b>MCY</b><br><b>MQN</b><br><b>MQY</b> |  | ANTA SINGOLA CIECA PER:<br>SINGLE STANDARD DOOR FOR:<br>PORTE PLEINE SINGLE POUR:<br>PUERTA SIMPLE LLENA PARA:<br>M/5A/0-5D/0               | MC-MQ/5APOA+MN-MY/F5BP | <b>MCN / 5APO/S</b><br><b>MCY</b><br><b>MQN</b><br><b>MQY</b> |   | ANTA SINGOLA CIECA CON SERRATURA PER:<br>SINGLE STANDARD DOOR WITH LOCK FOR:<br>PORTE PLEINE SINGLE AVEC SERRURE POUR:<br>PUERTA SIMPLE LLENA CON CERRADURA PARA:<br>M/5A/0-5D/0               | MC-MQ/5APOA/S+MN-MY/F5BP/S | Cm 45x1,9x147 h - Mc 0,042 - Kgl 9,2 - N°2  | <b>€ 459,00</b>  | Cm 45x1,9x147 h - Mc 0,042 - Kgl 9,2 - N°2  | <b>€ 572,00</b>  |
|  | <b>MCN / 1APO</b><br><b>MCY</b><br><b>MQN</b><br><b>MQY</b> |  | COPPIA ANTE CIECHE PER:<br>PAIR OF STANDARD DOORS FOR:<br>COUPLE DE PORTES PLEINES POUR:<br>PAR DE PUERTAS LLENAS PARA:<br>M/1A/0-1D/0      | MC-MQ/1APOA+MN-MY/F1BP | <b>MCN / 1APO/S</b><br><b>MCY</b><br><b>MQN</b><br><b>MQY</b> |   | COPPIA ANTE CIECHE CON SERRATURA PER:<br>PAIR OF STANDARD DOORS WITH LOCK FOR:<br>COUPLE DE PORTES PLEINES AVEC SERRURE POUR:<br>PAR DE PUERTAS LLENAS CON CERRADURA PARA:<br>M/1A/0-1D/0      | MC-MQ/1APOA/S+MN-MY/F1BP/S | Cm 90x1,9x147 h - Mc 0,044 - Kgl 16,3 - N°2 | <b>€ 850,00</b>  | Cm 90x1,9x147 h - Mc 0,044 - Kgl 16,3 - N°2 | <b>€ 963,00</b>  |
|  | <b>MCN / 5DPO</b><br><b>MCY</b><br><b>MQN</b><br><b>MQY</b> |  | ANTA SINGOLA CIECA PER:<br>SINGLE STANDARD DOOR FOR:<br>PORTE PLEINE SINGLE POUR:<br>PUERTA SIMPLE LLENA PARA:<br>M/5D/0                    | MC-MQ/5DPOA+MN-MY/F5DP | <b>MCN / 5DPO/S</b><br><b>MCY</b><br><b>MQN</b><br><b>MQY</b> |  | ANTA SINGOLA CIECA CON SERRATURA PER:<br>SINGLE STANDARD DOOR WITH LOCK FOR:<br>PORTE PLEINE SINGLE AVEC SERRURE POUR:<br>PUERTA SIMPLE LLENA CON CERRADURA PARA:<br>M/5D/0                    | MC-MQ/5DPOA/S+MN-MY/F5DP/S | Cm 45x1,9x217 h - Mc 0,057 - Kgl 15,3 - N°2 | <b>€ 643,00</b>  | Cm 45x1,9x217 h - Mc 0,057 - Kgl 15,3 - N°2 | <b>€ 756,00</b>  |
|  | <b>MCN / 1DPO</b><br><b>MCY</b><br><b>MQN</b><br><b>MQY</b> |  | COPPIA ANTE CIECHE PER:<br>PAIR OF STANDARD DOORS FOR:<br>COUPLE DE PORTES PLEINES POUR:<br>PAR DE PUERTAS LLENAS PARA:<br>M/1D/0           | MC-MQ/1DPOA+MN-MY/F1DP | <b>MCN / 1DPO/S</b><br><b>MCY</b><br><b>MQN</b><br><b>MQY</b> |   | COPPIA ANTE CIECHE CON SERRATURA PER:<br>PAIR OF STANDARD DOORS WITH LOCK FOR:<br>COUPLE DE PORTES PLEINES AVEC SERRURE POUR:<br>PAR DE PUERTAS LLENAS CON CERRADURA PARA:<br>M/1D/0           | MC-MQ/1DPOA/S+MN-MY/F1DP/S | Cm 90x1,9x217 h - Mc 0,060 - Kgl 27,7 - N°2 | <b>€ 1.216,0</b> | Cm 90x1,9x217 h - Mc 0,060 - Kgl 27,7 - N°2 | <b>€ 1.329,0</b> |

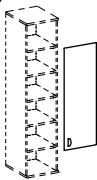
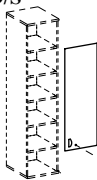
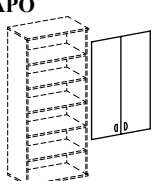
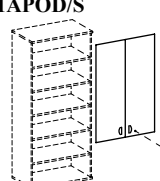
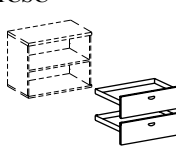
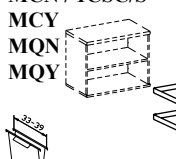
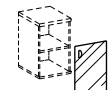
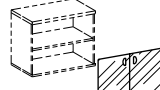
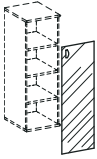
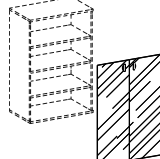
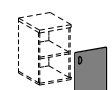
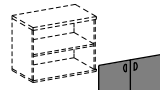
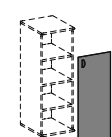
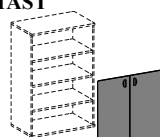
|  |   |   |  |                        |  |  |  |                             |   |                 |   |                 |
|--|---|---|--|------------------------|--|--|--|-----------------------------|---|-----------------|---|-----------------|
| ANTE PER ARMADI<br>DOORS FOR CABINETS<br>PORTES POUR ARMOIRES<br>PUERTAS PARA ARMARIOS | <b>MCN / SAPO</b><br><b>MCY</b><br><b>MQN</b><br><b>MQY</b> |    | ANTA SINGOLA CIECA PER:<br>SINGLE STANDARD DOOR FOR:<br>PORTE PLEINE SINGLE POUR:<br>PUERTA SIMPLE LLENA PARA:<br>M/5D/0   | MC-MQ/5APOA+MN-MY/F5BP | <b>MCN / SAPOD/S</b><br><b>MCY</b><br><b>MQN</b><br><b>MQY</b> |    | ANTA SINGOLA CIECA CON SERRATURA PER:<br>SINGLE STANDARD DOOR WITH LOCK FOR:<br>PORTE PLEINE SINGLE AVEC SERRURE POUR:<br>PUERTA SIMPLE LLENA CON CERRADURA PARA:<br>M/5D/0                            | MC-MQ/5APODA/S+MN-MY/F5BP/S | Cm 45x1,9x147 h - Mc 0,042 - Kgl 9,2 - N°2  | <b>€ 459,00</b> | Cm 45x1,9x147 h - Mc 0,042 - Kgl 9,2 - N°2  | <b>€ 572,00</b> |
|  | <b>MCN / IAPO</b><br><b>MCY</b><br><b>MQN</b><br><b>MQY</b> |    | COPPIA ANTE CIECHE PER:<br>PAIR OF STANDARD DOORS FOR:<br>COUPLE DE PORTES PLEINES POUR:<br>PAR DE PUERTAS LLENAS PARA:<br>M/1D/0                                    | MC-MQ/IAPOA+MN-MY/F1BP | <b>MCN / IAPOD/S</b><br><b>MCY</b><br><b>MQN</b><br><b>MQY</b> |    | COPPIA ANTE CIECHE CON SERRATURA PER:<br>PAIR OF STANDARD DOORS WITH LOCK FOR:<br>COUPLE DE PORTES PLEINES AVEC SERRURE POUR:<br>PAR DE PUERTAS LLENAS CON CERRADURA PARA:<br>M/1D/0                   | MC-MQ/IAPODA/S+MN-MY/F1BP/S | Cm 90x1,9x147 h - Mc 0,044 - Kgl 16,3 - N°2 | <b>€ 850,00</b> | Cm 90x1,9x147 h - Mc 0,044 - Kgl 16,3 - N°2 | <b>€ 963,00</b> |
|  | <b>MCN / ICSC</b><br><b>MCY</b><br><b>MQN</b><br><b>MQY</b> |    | COPPIA CASSETTI SCHEDARIO PER:<br>PAIR OF FILING DRAWERS FOR:<br>COUPLE DE TIROIRS FICHER POUR:<br>PAR DE CAJONES FICHERO PARA:<br>M/1B/0-1A/0-1D/0                  | MC-MQ/ICSCA+MN-MY/F1CS | <b>MCN / ICSC/S</b><br><b>MCY</b><br><b>MQN</b><br><b>MQY</b>  |    | COPPIA CASSETTI SCHEDARIO CON SERRATURA PER:<br>PAIR OF FILING DRAWERS WITH LOCK FOR:<br>COUPLE DE TIROIRS FICHER AVEC SERRURE POUR:<br>PAR DE CAJONES FICHERO CON CERRADURA PARA:<br>M/1B/0-1A/0-1D/0 | MC-MQ/ICSCA/S+MN-MY/F1CS/S  | Cm 90x48x77 h - Mc 0,100 - Kgl 20,3 - N°2   | <b>€ 810,00</b> | Cm 90x48x77 h - Mc 0,100 - Kgl 20,3 - N°2   | <b>€ 965,00</b> |
|  | <b>MCN / 5BVT</b><br><b>MCY</b><br><b>MQN</b><br><b>MQY</b> |  | ANTA SINGOLA VETRO PER:<br>SINGLE GLASS DOOR FOR:<br>PORTE EN VERRE SINGLE POUR:<br>PUERTA SIMPLE DE VIDRIO PARA:<br>M/5B/0-5A/0-5D/0                                | M/5BVT+MN-MY/F5BV      | <b>MCN / 1BVT</b><br><b>MCY</b><br><b>MQN</b><br><b>MQY</b>    |  | COPPIA ANTE VETRO PER:<br>PAIR OF GLASS DOORS FOR:<br>COUPLE DE PORTES EN VERRE POUR:<br>PAR DE PUERTAS DE VIDRIO PARA:<br>M/1B/0-1A/0-1D/0  | M/1BVT+MN-MY/F1BV           | Cm 45x0,5x77 h - Mc 0,026 - Kgl 4,7 - N°2   | <b>€ 135,0</b>  | Cm 90x0,5x77 h - Mc 0,026 - Kgl 8,2 - N°2   | <b>€ 214,00</b> |
|  | <b>MCN / 5AVT</b><br><b>MCY</b><br><b>MQN</b><br><b>MQY</b> |  | ANTA SINGOLA VETRO PER:<br>SINGLE GLASS DOOR FOR:<br>PORTE EN VERRE SINGLE POUR:<br>PUERTA SIMPLE DE VIDRIO PARA:<br>M/5A/0-5D/0                                     | M/5AVTA+MN-MY/F5BV     | <b>MCN / 1AVT</b><br><b>MCY</b><br><b>MQN</b><br><b>MQY</b>    |  | COPPIA ANTE VETRO PER:<br>PAIR OF GLASS DOORS FOR:<br>COUPLE DE PORTES EN VERRE POUR:<br>PAR DE PUERTAS DE VIDRIO PARA:<br>M/1A/0-1D/0   | M/1AVTA+MN-MY/F1BV          | Cm 45x0,5x147 h - Mc 0,050 - Kgl 9,5 - N°2  | <b>€ 174,00</b> | Cm 90x0,5x147 h - Mc 0,050 - Kgl 16,0 - N°2 | <b>€ 280,00</b> |
|  | <b>MCN / 5BST</b><br><b>MCY</b><br><b>MQN</b><br><b>MQY</b> |  | ANTA SINGOLA VETRO SATINATO PER:<br>SINGLE SATIN GLASS DOOR FOR:<br>PORTE EN VERRE SATINÉ SINGLE POUR:<br>PUERTA SIMPLE DE VIDRIO SATINADO PARA:<br>M/5B/0-5A/0-5D/0 | M/5BSTA+MN-MY/F5BV     | <b>MCN / 1BST</b><br><b>MCY</b><br><b>MQN</b><br><b>MQY</b>    |  | COPPIA ANTE VETRO SATINATO PER:<br>PAIR OF SATIN GLASS DOORS FOR:<br>COUPLE DE PORTES EN VERRE SATINÉ POUR:<br>PAR DE PUERTAS DE VIDRIO SATINADO PARA:<br>M/1B/0-1A/0-1D/0                             | M/1BSTA+MN-MY/F1BV          | Cm 45x0,5x77 h - Mc 0,026 - Kgl 4,7 - N°2   | <b>€ 161,00</b> | Cm 90x0,5x77 h - Mc 0,026 - Kgl 8,2 - N°2   | <b>€ 259,00</b> |
|  | <b>MCN / 5AST</b><br><b>MCY</b><br><b>MQN</b><br><b>MQY</b> |  | ANTA SINGOLA VETRO SATINATO PER:<br>SINGLE SATIN GLASS DOOR FOR:<br>PORTE EN VERRE SATINÉ SINGLE POUR:<br>PUERTA SIMPLE DE VIDRIO SATINADO PARA:<br>M/5A/0-5D/0      | M/5ASTA+MN-MY/F5BV     | <b>MCN / 1AST</b><br><b>MCY</b><br><b>MQN</b><br><b>MQY</b>    |  | COPPIA ANTE VETRO SATINATO PER:<br>PAIR OF SATIN GLASS DOORS FOR:<br>COUPLE DE PORTES EN VERRE SATINÉ POUR:<br>PAR DE PUERTAS DE VIDRIO SATINADO PARA:<br>M/1A/0-1D/0                                  | M/1ASTA+MN-MY/F1BV          | Cm 45x0,5x147 h - Mc 0,050 - Kgl 9,5 - N°2  | <b>€ 222,00</b> | Cm 90x0,5x147 h - Mc 0,050 - Kgl 16,0 - N°2 | <b>€ 354,00</b> |

COMPONENTI PER LIBRERIA E ARMADI  
COMPONENTS FOR BOOKCASES AND CABINETS  
COMPOSANTS POUR BIBLIOTHÈQUES ET ARMOIRES  
COMPONENTES PARA BIBLIOTECAS Y ARMARIOS

**MM / 1AP27**

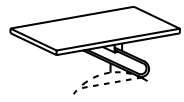

APPENDIABITI INTERNO CON RIPIANO IN MELAMINICO  
COAT STAND INSIDE THE CABINET WITH MELAMINE  
SHELVES  
PORTE-MANTEAUX INTERNE POUR ÉTAGÈRES MÉLAMINÉ  
PERCHERO INTERNO ARMARIO PARA ESTANTES  
MELAMINICOS

MM/1AP27

Cm 90x48x2,5 h - Mc 0,015 - Kgl 3,5 - N°1 **€ 98,00**

**MM / 5AP27**

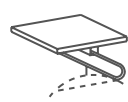

APPENDIABITI INTERNO CON RIPIANO IN MELAMINICO  
COAT STAND INSIDE THE CABINET WITH MELAMINE  
SHELVES  
PORTE-MANTEAUX INTERNE POUR ÉTAGÈRES MÉLAMINÉ  
PERCHERO INTERNO ARMARIO PARA ESTANTES  
MELAMINICOS

MM/5AP27

Cm 45x48x2,5 h - Mc 0,010 - Kgl 2,5 - N°1 **€ 90,00**

**B / 114M**

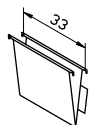

CARTELLA SCHEDARIO PER RIPIANI METALLICI:  
FILE FOR METAL SHELVES:  
DOSSIER POUR ÉTAGÈRES MÉTALLIQUES:  
CARPETA PARA ESTANTES METALICOS:  
N/SRBM-IRBM

B/114M

Cm 33x28 h - Mc 0,001 - Kgl 0,11 - N°1 **€ 2,80**

**B / 106CPL**



CARTELLA SCHEDARIO  
FILE FOR FILING DRAWER  
DOSSIER POUR FICHER  
CARPETA PARA FICHERO

B/106CPL

Cm 39x25 h - Mc 0,001 - Kgl 0,11 - N°1 **€ 2,80**

**B / 105CPL**

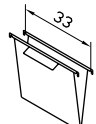

SERRATURA PER ANTE E SCHEDARI CIECHI  
LOCK FOR STANDARD DOORS AND FILING DRAWERS  
SERRURE POUR PORTES PLEINES ET FICHIERS  
CERRADURA PARA PUERTAS LLENAS Y FICHEROS

B/105CPL

Cm 33x25 h - Mc 0,001 - Kgl 0,11 - N°1 **€ 2,70**

**BK / CDPR**

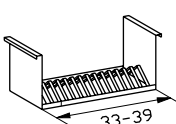

SUPPORTO PER N° 15÷18 C. D. PER CASSETTI SCHEDARIO  
SUPPORT FOR 15÷18 C. D. FOR FILING DRAWERS  
SUPPORT POUR 15÷18 C. D. POUR TIROIRS FICHER  
SOPORTE PARA 15÷18 C. D. PARA CAJONES FICHERO

BK/CDPR

Cm 33x18x17 h - Mc 0,011 - Kgl 2,5 - N°1 **€ 71,00**

**Z / CAF**

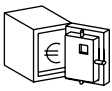

CASSAFORTE ELETTRONICA PER:  
ELECTRONIC SAFE FOR:  
COFFRE-FORT ÉLECTRONIQUE POUR:  
CAJA DE CAUDALES ELECTRÓNICA PARA:  
M/LD-LE-5B/1-1B/1-5A/1-5A/3-1A/1-1A/3-5D/1-1D/1-1D/2

Z/CAF

Cm 35x40x50 h - Mc 0,08 - Kgl 58,0 - N°1 **€ 2.481,00**

**TK / 5FR**



FRIGORIFERO PER:  
SMALL REFRIGERATOR FOR:  
PETIT FRIGIDAIRE POUR:  
MUEBLE FRIGORÍFICO PARA:  
M/LE-5B/1-5A/1-5A/3-5D/1-5D/2

TK/5FR

Cm 38x40x50 h - Mc 0,088 - Kgl 16,5 - N°1 **€ 1.420,0**

**TK / 1FR**

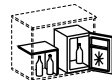

FRIGORIFERO PER:  
SMALL REFRIGERATOR FOR:  
PETIT FRIGIDAIRE POUR:  
MUEBLE FRIGORÍFICO PARA:  
M/LD-1B/1-1A/1-1A/3-1D/1-1D/2

TK/5FR-TK/1FRPIA

Cm 38x40x50 h - Mc 0,097 - Kgl 20,7 - N°2 **€ 1.492,00**

**E / SER**

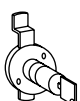

SERRATURA PER ANTE E SCHEDARI CIECHI  
LOCK FOR STANDARD DOORS AND FILING DRAWERS  
SERRURE POUR PORTES PLEINES ET FICHIERS  
CERRADURA PARA PUERTAS LLENAS Y FICHEROS

E/SER

Mc 0,001 - Kgl 0,2 - N°1 **€ 47,00**

**E / SER / FER**

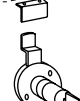

SERRATURA CON FERRAMENTA PER ANTE E SCHEDARI CIECHI  
LOCK WITH FITTINGS FOR STANDARD DOORS AND FILING  
DRAWERS  
SERRURE AVEC FERREMENTS POUR PORTES PLEINES ET FICHIERS  
CERRADURA CON FERRETERÍA PARA PUERTAS LLENAS Y  
FICHEROS

E/SER/FER

Mc 0,001 - Kgl 0,2 - N°1 **€ 61,00**

**COME UTILIZZARE I CASSETTI SCHEDARIO MCN-MCY-MQN-MQY/1CSC-1CSC/S**  
**HOW TO USE THE FILING DRAWERS MCN-MCY-MQN-MQY/1CSC-1CSC/S**  
**COMMENT UTILISER LES TIROIRS FICHER MCN-MCY-MQN-MQY/1CSC-1CSC/S**  
**CÓMO USAR LOS CAJONES FICHERO MCN-MCY-MQN-MQY/1CSC-1CSC/S**

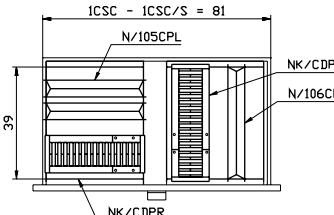

TAVOLI RIUNIONE CON PIANO IN LEGNO  
MEETING TABLES WITH WOODEN TOP  
TABLES DE RÉUNIONS AVEC DESSUS EN BOIS  
MESAS DE REUNIÓN CON TAPA DE MADERA

**MCN / 120RTAR**  
**MCY**  
**MQN**  
**MQY**

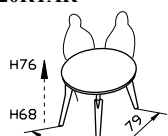

TAVOLO RIUNIONE SAGOMATO REGISTRABILE (6 POSTI)  
ADJUSTABLE SHAPED MEETING TABLE (6 SEATS)  
TABLE DE RÉUNION FAÇONNÉ RÉGLABLE (6 PLACES)  
MESA DE REUNIÓN CURVADA AJUSTABLE (6 ASIENTOS)

MCN-MY/R1G+MN-MY/R2G+MC-MQ/12PSTAR

Cm ø120x68-76 h - Mc 0,217 - Kgl 40,2 - N°3 **€ 1.436,0**

**MCN / 200RB**  
**MCY**  
**MQN**  
**MQY**



TAVOLO RIUNIONE SAGOMATO REGISTRABILE (8 POSTI)  
ADJUSTABLE SHAPED MEETING TABLE (8 SEATS)  
TABLE DE RÉUNION FAÇONNÉ RÉGLABLE (8 PLACES)  
MESA DE REUNIÓN CURVADA AJUSTABLE (8 ASIENTOS)

N.2 MN-MY/R2G+MC-MQ/20BPS

Cm 200x120x68-76 h - Mc 0,303 - Kgl 57,4 - N°3 **€ 2.049,00**

**MCN / 140RA**  
**MCY**  
**MQN**  
**MQY**

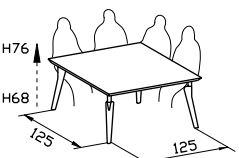

TAVOLO RIUNIONE REGISTRABILE (8 POSTI)  
ADJUSTABLE MEETING TABLE (8 SEATS)  
TABLE DE RÉUNION RÉGLABLE (8 PLACES)  
MESA DE REUNIÓN AJUSTABLE (8 ASIENTOS)

N.2 MN-MY/R2G+MC-MQ/14PAS

Cm 140x140x68-76 h - Mc 0,341 - Kgl 64,4 - N°3 **€ 2.202,00**

TAVOLI RIUNIONE CON PIANO IN LEGNO  
MEETING TABLES WITH WOODEN TOP  
TABLES DE RÉUNIONS AVEC DESSUS EN BOIS  
MESAS DE REUNIÓN CON TAPA DE MADERA

**MCN / 280RTA**  
**MCY**  
**MQN**  
**MQY**

TAVOLO RIUNIONE SAGOMATO REGISTRABILE (10 POSTI)  
ADJUSTABLE SHAPED MEETING TABLE (10 SEATS)  
TABLE DE RÉUNION FAÇONNÉ RÉGLABLE (10 PLACES)  
MESA DE REUNIÓN CURVADA AJUSTABLE (10 ASIENTOS)

N.3 MN-MY/R2G+N.2 MC-MQ/14PSTAT+  
MN-MY/14GIUN

€ 3.214,00

Cm 280x120x68-76 h - Mc 0,413 - Kgl 104,2 - N°6

**MCN / 420RTA**  
**MCY**  
**MQN**  
**MQY**

TAVOLO RIUNIONE SAGOMATO REGISTRABILE (14 POSTI)  
ADJUSTABLE SHAPED MEETING TABLE (14 SEATS)  
TABLE DE RÉUNION FAÇONNÉ RÉGLABLE (14 PLACES)  
MESA DE REUNIÓN CURVADA AJUSTABLE (14 ASIENTOS)

N.4 MN-MY/R2G+N.2 MC-MQ/14PSTAT+  
MC-MQ/14PSTAC+N.2 MN-MY/14GIUN

€ 4.706,00

Cm 420x120x68-76 h - Mc 0,596 - Kgl 155,4 - N°9

**MCN / 560RTA**  
**MCY**  
**MQN**  
**MQY**

TAVOLO RIUNIONE SAGOMATO REGISTRABILE (18 POSTI)  
ADJUSTABLE SHAPED MEETING TABLE (18 SEATS)  
TABLE DE RÉUNION FAÇONNÉ RÉGLABLE (18 PLACES)  
MESA DE REUNIÓN CURVADA AJUSTABLE (18 ASIENTOS)

N.5 MN-MY/R2G+N.2 MC-MQ/14PSTAT+  
N.2 MC-MQ/14PSTAC+N.3 MN-MY/14GIUN

€ 6.198,00

Cm 560x120x68-76 h - Mc 0,779 - Kgl 206,6 - N°12

**MN / STA**  
**MY**

SOTTOMANO PER TAVOLO RIUNIONI:  
DESK PAD FOR MEETING TABLE:  
SOUS-MAIN POUR TABLE DE RÉUNION:  
VADE PARA MESA DE REUNIÓN:  
M/140RA-280RTA-420RTA-560RTA

MN-MY/STA

€ 302,00

Cm 53x35 - Mc 0,002 - Kgl 2,8 - N°1

TAVOLI RIUNIONE CON PIANO IN VETRO  
MEETING TABLES WITH GLASS TOP  
TABLES DE RÉUNION AVEC DESSUS EN VERRE  
MESAS DE REUNIÓN CON TAPA DE VIDRIO

**MCN / VT120RTAR**  
**MCY**  
**MQN**  
**MQY**

TAVOLO RIUNIONE SAGOMATO REGISTRABILE (6 POSTI)  
ADJUSTABLE SHAPED MEETING TABLE (6 SEATS)  
TABLE DE RÉUNION FAÇONNÉ RÉGLABLE (6 PLACES)  
MESA DE REUNIÓN CURVADA AJUSTABLE (6 ASIENTOS)

MN-MY/VTR1G+MN-MY/VTR2G+MV/12TARPV

€ 2.264,00

Cm ø120x68-76 h - Mc 0,322 - Kgl 88,4 - N°3

**MCN / VT200RB**  
**MCY**  
**MQN**  
**MQY**

TAVOLO RIUNIONE SAGOMATO REGISTRABILE (8 POSTI)  
ADJUSTABLE SHAPED MEETING TABLE (8 SEATS)  
TABLE DE RÉUNION FAÇONNÉ RÉGLABLE (8 PLACES)  
MESA DE REUNIÓN CURVADA AJUSTABLE (8 ASIENTOS)

N.2 MN-MY/VTR2G+MV/20BPV

€ 2.809,00

Cm 200x120x68-76 h - Mc 0,461 - Kgl 112,8 - N°3

**MCN / VT140RTA**  
**MCY**  
**MQN**  
**MQY**

TAVOLO RIUNIONE REGISTRABILE (8 POSTI)  
ADJUSTABLE MEETING TABLE (8 SEATS)  
TABLE DE RÉUNION RÉGLABLE (8 PLACES)  
MESA DE REUNIÓN AJUSTABLE (8 ASIENTOS)

N.2 MN-MY/VTR2G+MV/14APV

€ 2.654,00

Cm 140x120x68-76 h - Mc 0,358 - Kgl 107,1 - N°3

**MCN / VT280RTA**  
**MCY**  
**MQN**  
**MQY**

SENZA GIUNZIONE IN CUIO SUL TOP  
WITHOUT LEATHER JUNCTION ON THE TOP  
SANS JOINTION EN CUIR SUR DESSUS  
SIN CONEXIÓN DE CUERO SOBRE TAPA

N.2 MN-MY/VTR2G+MN-MY/VTR2TA+  
N.2 MV/14APV

€ 4.088,00

Cm 280x120x68-76 h - Mc 0,686 - Kgl 211,9 - N°5

**MCN / VT420RTA**  
**MCY**  
**MQN**  
**MQY**

SENZA GIUNZIONE IN CUIO SUL TOP  
WITHOUT LEATHER JUNCTION ON THE TOP  
SANS JOINTION EN CUIR SUR DESSUS  
SIN CONEXIÓN DE CUERO SOBRE TAPA

N.2 MN-MY/VTR2G+N.2 MN-MY/VTR2TA+  
N.3 MV/14APV

€ 6.054,00

Cm 420x120x68-76 h - Mc 1,014 - Kgl 316,7 - N°7



|  |  |   |                   |
|--|--|---|-------------------|
| TAVOLI RIUNIONE CON PIANO IN VETRO<br>MEETING TABLES WITH GLASS TOP<br>TABLES DE RÉUNION AVEC DESSUS EN VERRE<br>MESAS DE REUNION CON TAPA DE VIDRIO | <p><b>MCN / VT560RTA</b><br/><b>MCY</b><br/><b>MQN</b><br/><b>MQY</b></p> <p>SENZA GIUNZIONE IN CUIO SUL TOP<br/>WITHOUT LEATHER JUNCTION ON THE TOP<br/>SANS JONCTION EN CUIR SUR DESSUS<br/>SIN CONEXIÓN DE CUERO SOBRE TAPA</p> <p>TAVOLO RIUNIONE SAGOMATO REGISTRABILE (18 POSTI)<br/>ADJUSTABLE SHAPED MEETING TABLE (18 SEATS)<br/>TABLE DE RÉUNION FAÇONNÉE RÉGLABLE (18 PLACES)<br/>MESA DE REUNIÓN CURVADA AJUSTABLE (18 ASIENTOS)</p> <p>N.2 MN-MY/VTR2G+N.3 MN-MY/VTR2TA+<br/>N.4 MV/14APV</p> | <p>€ 8.020,00</p>   |                   |
|  | <p><b>Cm 560x120x68-76 h - Mc 1,342 - Kgl 421,5 - N°9</b></p>  | <p><b>MN / VT14GIUN</b><br/><b>MY</b></p> <p>GIUNZIONE IN CUIO PER TAVOLO RIUNIONE IN VETRO<br/>LEATHER JUNCTION FOR MEETING TABLE WITH GLASS TOP<br/>JONCTION EN CUIR POUR TABLE DE RÉUNION AVEC DESSUS EN VERRE<br/>CONEXIÓN DE CUERO PARA MESA DE REUNIÓN CON TAPA DE VIDRIO</p> <p>MN-MY/VT14GIUN</p>   | <p>€ 347,00</p>   |
|  | <p><b>MN / STA</b><br/><b>MY</b></p> <p>SOTTOMANO PER TAVOLO RIUNIONE:<br/>DESK PAD FOR MEETING TABLE:<br/>SOUS-MAIN POUR TABLE DE RÉUNION:<br/>VADE PARA MESA DE REUNIÓN:<br/>M/140RA-280RTA-420RTA-560RTA</p> <p>MN-MY/STA</p>   | <p>€ 302,00</p>   |                   |
|  | <p><b>Cm 120x12x0,6 - Mc 0,015 - Kgl 1,5 - N°1</b></p>   | <p><b>Cm 53x35 - Mc 0,002 - Kgl 2,8 - N°1</b></p>   |                   |
| TAVOLINI ATTESA<br>SIDE TABLES<br>PETITES TABLES D'ATTENTE<br>MESITAS DE ESPERA  | <p><b>MCN / 70TV</b><br/><b>MCY</b><br/><b>MQN</b><br/><b>MQY</b></p> <p>TAVOLINO ATTESA CON PIANO IN LEGNO SAGOMATO<br/>SHAPED SIDE TABLE WITH WOODEN TOP<br/>PETITE TABLE D'ATTENTE FAÇONNÉE AVEC DESSUS EN BOIS<br/>MESITA DE ESPERA CURVADA CON TAPA EN MADERA</p> <p>MM/4GA+MC-MQ/7PSTV</p>   | <p>€ 808,00</p>   |                   |
|  | <p><b>Cm 70x70x42 h - Mc 0,050 - Kgl 19,6 - N°2</b></p>  | <p><b>MM / VT70TV</b></p> <p>TAVOLINO ATTESA CON PIANO IN VETRO SAGOMATO<br/>SHAPED SIDE TABLE WITH GLASS TOP<br/>PETITE TABLE D'ATTENTE FAÇONNÉE AVEC DESSUS EN VERRE<br/>MESITA DE ESPERA CURVADA CON TAPA DE VIDRIO</p> <p>MM/VT4GA+MV/70PV</p>  | <p>€ 1.057,0</p>  |
|  | <p><b>Cm 70x70x42 h - Mc 0,060 - Kgl 30,9 - N°2</b></p>  | <p><b>MCN / 120TV</b><br/><b>MCY</b><br/><b>MQN</b><br/><b>MQY</b></p> <p>TAVOLINO ATTESA CON PIANO IN LEGNO SAGOMATO<br/>SHAPED SIDE TABLE WITH WOODEN TOP<br/>PETITE TABLE D'ATTENTE FAÇONNÉE AVEC DESSUS EN BOIS<br/>MESITA DE ESPERA CURVADA CON TAPA EN MADERA</p> <p>MM/4GA+MC-MQ/ALPS</p>  | <p>€ 969,00</p>   |
|  | <p><b>Cm 120x60x42 h - Mc 0,067 - Kgl 24,6 - N°2</b></p>   | <p><b>MM / VT120TV</b></p> <p>TAVOLINO ATTESA CON PIANO IN VETRO SAGOMATO<br/>SHAPED SIDE TABLE WITH GLASS TOP<br/>PETITE TABLE D'ATTENTE FAÇONNÉE AVEC DESSUS EN VERRE<br/>MESITA DE ESPERA CURVADA CON TAPA DE VIDRIO</p> <p>MM/VT4GA+MV/ALPV</p>   | <p>€ 1.192,0</p>  |
| <p><b>Cm 120x60x42 h - Mc 0,083 - Kgl 39,6 - N°2</b></p>   | <p><b>MCN / 110TV</b><br/><b>MCY</b><br/><b>MQN</b><br/><b>MQY</b></p> <p>TAVOLINO ATTESA CON PIANO IN LEGNO SAGOMATO<br/>SHAPED SIDE TABLE WITH WOODEN TOP<br/>PETITE TABLE D'ATTENTE FAÇONNÉE AVEC DESSUS EN BOIS<br/>MESITA DE ESPERA CURVADA CON TAPA EN MADERA</p> <p>MM/3GA+MC-MQ/REPS</p>   | <p>€ 926,00</p>   |                   |
| <p><b>Cm 110x80x42 h - Mc 0,078 - Kgl 22,5 - N°2</b></p>   | <p><b>MM / VT110TV</b></p> <p>TAVOLINO ATTESA CON PIANO IN VETRO SAGOMATO<br/>SHAPED SIDE TABLE WITH GLASS TOP<br/>PETITE TABLE D'ATTENTE FAÇONNÉE AVEC DESSUS EN VERRE<br/>MESITA DE ESPERA CURVADA CON TAPA DE VIDRIO</p> <p>MM/VT3GA+MV/REPV</p>  | <p>€ 1.175,0</p>  |                   |
| <p><b>Cm 110x80x42 h - Mc 0,093 - Kgl 37,3 - N°2</b></p>   |  |   |                   |
| MOBILE BAR<br>BAR CABINET<br>MEUBLE BAR<br>MUEBLE BAR  | <p><b>MCN / 150BAR</b><br/><b>MCY</b></p> <p>MOBILE BAR CON SOPRALZO LEGNO<br/>BAR CABINET WITH WOODEN RAISED ELEMENT<br/>MEUBLE BAR AVEC REHAUSSE EN BOIS<br/>MUEBLE BAR CON MONTANTE DE MADERA</p> <p>MM/4MBA+MC/15PSBAI+MC/15SOPBAI+<br/>MN-MY/15SCBAI+NM/BAL+<br/>MC/BBPOA+MN-MY/F1BP</p>  | <p>€ 5.579,00</p>   |                   |
|  | <p><b>Cm 156x98x110 h - Mc 0,633 - Kgl 103,0 - N°7</b></p>   | <p><b>MCN / VT150BAR</b><br/><b>MCY</b></p> <p>MOBILE BAR CON SOPRALZO VETRO<br/>BAR CABINET WITH GLASS RAISED ELEMENT<br/>MEUBLE BAR AVEC REHAUSSE EN VERRE<br/>MUEBLE BAR CON MONTANTE DE VIDRIO</p> <p>MM/4MBA+MC/15PSBAI+MCV/15SOPBAI+<br/>MN-MY/15SCBAI+NM/BAL+<br/>MC/BBPOA+MN-MY/F1BP</p>  | <p>€ 5.613,00</p> |
|  | <p><b>Cm 156x98x110 h - Mc 0,644 - Kgl 119,4 - N°7</b></p>   | <p><b>MCN / 150BARF</b><br/><b>MCY</b></p> <p>MOBILE BAR CON SOPRALZO LEGNO E FRIGORIFERO<br/>BAR CABINET+WOODEN RAISED ELEMENT+REFRIGERATOR<br/>MEUBLE BAR AVEC REHAUSSE EN BOIS ET FRIGIDAIRE<br/>MUEBLE BAR CON MONTANTE DE MADERA + FRIGORIFICO</p> <p>MM/4MBA+MC/15PSBAI+MC/15SOPBAI+<br/>MN-MY/15SCBAI+NM/BAL+MC/BBPOA+<br/>TK/5FR+MN-MY/F1BP</p> | <p>€ 6.998,00</p> |
| <p><b>Cm 156x98x110 h - Mc 0,773 - Kgl 136,1 - N°8</b></p>   | <p><b>MCN / VT150BARF</b><br/><b>MCY</b></p> <p>MOBILE BAR CON SOPRALZO VETRO E FRIGORIFERO<br/>BAR CABINET+GLASS RAISED ELEMENT+REFRIGERATOR<br/>MEUBLE BAR AVEC REHAUSSE EN VERRE ET FRIGIDAIRE<br/>MUEBLE BAR CON MONTANTE DE VIDRIO + FRIGORIFICO</p> <p>MM/4MBA+MC/15PSBAI+MCV/15SOPBAI+<br/>MN-MY/15SCBAI+NM/BAL+MC/BBPOA+<br/>TK/5FR+MN-MY/F1BP</p>   | <p>€ 7.033,00</p>   |                   |
| <p><b>Cm 156x98x110 h - Mc 0,784 - Kgl 145,0 - N°8</b></p>   |  |   |                   |

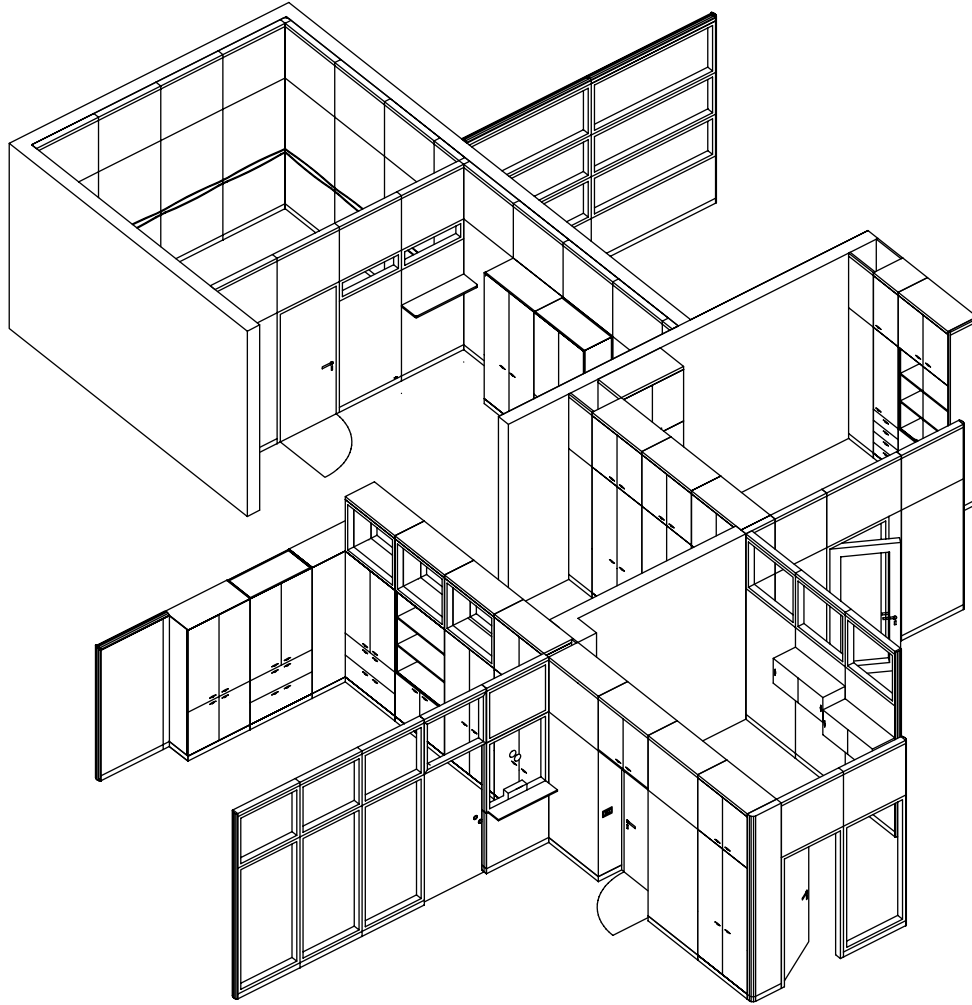

**NEL CATALOGO DI MASTER POINT SONO PRESENTI DIVERSE IMMAGINI RAFFIGURANTI LE PARETI DIVISORIE, ATTREZZATE, RIVESTIMENTI MURALI. PER UNA DETTAGLIATA ANALISI DELLE NOSTRE PROPOSTE VI INVITIAMO A CONSULTARE IL LISTINO DELLA LINEA “PASSWORD”.**

IN THE MASTER POINT CATALOGUE YOU FIND SEVERAL IMAGES REPRESENTING THE PARTITION WALLS, THE EQUIPPED WALLS AND THE WALL LINING. FOR ANY DETAILED INFORMATION ABOUT OUR PROPOSALS WE REFER YOU TO THE “PASSWORD” PRICE LIST.

DANS LE CATALOGUE DE MASTER POINT IL Y A PLUSIEURS IMAGES QUI RÉPRÉSENTENT LES CLOISONS, LES CLOISONS ÉQUIPÉES, LES REVÊTEMENTS MURAUX. POUR TOUS RENSEIGNEMENTS DÉTAILLÉS DES NOS PROPOSITIONS NOUS VOUS PRIONS DE CONSULTER LA LISTE DES PRIX “PASSWORD”.



EN EL CATÁLOGO MASTER POINT SE ILUSTRAN VARIAS IMÁGENES QUE REPRESENTAN LOS TABIQUES DIVISORIOS, EQUIPADOS Y LOS REVESTIMIENTOS MURALES. PARA INFORMACIONES MÁS DETALLADAS SOBRE NUESTRAS PROPUESTAS LES INVITAMOS A CONSULTAR LA LISTA DE PRECIOS DE LA LÍNEA «PASSWORD».

ATTENTION: PRICES TO BE SURCHARGED BY 5%



ATTENZIONE: PREZZI DA MAGGIORARE DEL 5%

| LINEA<br>LINE         | ARTICOLO<br>ARTICLE     | BRACCIOILI<br>ARMS         | CUOIO<br>THICK LEATHER     | FUNZIONI<br>FUNCTIONS                  | DIMENSIONI<br>DIMENSIONS                       |                    |                     |                      | COLLI<br>PACKINGS      |                          |                        |                          | PREZZO - PRICE - PRIX - PRECIO |          |     |            |          |            |
|-----------------------|-------------------------|----------------------------|----------------------------|--|--|--------------------|---------------------|----------------------|------------------------|--------------------------|------------------------|--------------------------|--------------------------------|----------|-----|------------|----------|------------|
|                       |                         |                            |                            |  | N°<br>COLLI                                    | m <sup>3</sup>     | KG<br>NETTO         | KG<br>LORDO          | CAT. T                 | CAT. M                   | CAT. L                 | CAT. P                   | CAT. C                         |          |     |            |          |            |
|                       |                         |                            |                            |  |  |                    |                     |                      | TREVIRA<br>TREVIRA     | MICROFIBRA<br>MICROFIBER | ALCANTARA<br>ALCANTARA | PELLE<br>THIN<br>LEATHER | CUOIO<br>THICK<br>LEATHER      |          |     |            |          |            |
| MASTER                |                         | MCN/151G                   | Ciliegio<br>Cherry<br>wood | CB76                                   | 2-8  | 62                 | 70                  | 133<br>124           | 57<br>48               | 1                        | 0,44                   | 17,0                     | 18,5                           | ---      | --- | ---        | ---      | € 1.158,00 |
|                       |                         | MCY/151G                   |                            | CI71                                   |  |                    |                     |                      |                        |                          |                        |                          |                                |          |     |            |          |            |
|                       |                         | MQN/151G                   | Wengé<br>Wengé<br>wood     | CB76                                   |  |                    |                     |                      |                        |                          |                        |                          |                                |          |     |            |          |            |
|                       |                         | MQY/151G                   |                            | CI71                                   |  |                    |                     |                      |                        |                          |                        |                          |                                |          |     |            |          |            |
|                       |                         | MCN/151GO                  | Ciliegio<br>Cherry<br>wood | CB76                                   | 2-6-8  | 62                 | 70                  | 133<br>124           | 57<br>48               | 1                        | 0,44                   | 17,5                     | 19,0                           | ---      | --- | ---        | ---      | € 1.281,00 |
|                       |                         | MCY/151GO                  |                            | CI71                                   |  |                    |                     |                      |                        |                          |                        |                          |                                |          |     |            |          |            |
|                       |                         | MQN/151GO                  | Wengé<br>Wengé<br>wood     | CB76                                   |  |                    |                     |                      |                        |                          |                        |                          |                                |          |     |            |          |            |
|                       |                         | MQY/151GO                  |                            | CI71                                   |  |                    |                     |                      |                        |                          |                        |                          |                                |          |     |            |          |            |
|                       |                         | MCN/153G                   | Ciliegio<br>Cherry<br>wood | CB76                                   | 2-8  | 62                 | 70                  | 92<br>83             | 57<br>48               | 1                        | 0,32                   | 15                       | 16,5                           | ---      | --- | ---        | ---      | € 1.079,00 |
|                       |                         | MCY/153G                   |                            | CI71                                   |  |                    |                     |                      |                        |                          |                        |                          |                                |          |     |            |          |            |
|                       |                         | MQN/153G                   | Wengé<br>Wengé<br>wood     | CB76                                   |  |                    |                     |                      |                        |                          |                        |                          |                                |          |     |            |          |            |
|                       |                         | MQY/153G                   |                            | CI71                                   |  |                    |                     |                      |                        |                          |                        |                          |                                |          |     |            |          |            |
|                       |                         | MCN/153GO                  | Ciliegio<br>Cherry<br>wood | CB76                                   | 2-6-8  | 62                 | 70                  | 92<br>83             | 57<br>48               | 1                        | 0,32                   | 15,5                     | 17                             | ---      | --- | ---        | ---      | € 1.202,00 |
|                       |                         | MCY/153GO                  |                            | CI71                                   |  |                    |                     |                      |                        |                          |                        |                          |                                |          |     |            |          |            |
|                       |                         | MQN/153GO                  | Wengé<br>Wengé<br>wood     | CB76                                   |  |                    |                     |                      |                        |                          |                        |                          |                                |          |     |            |          |            |
|                       |                         | MQY/153GO                  |                            | CI71                                   |  |                    |                     |                      |                        |                          |                        |                          |                                |          |     |            |          |            |
|                       | MCN/157                 | Ciliegio<br>Cherry<br>wood | CB76                       | ---                                    | 56   | 56                 | 92                  | 48                   | 1                      | 0,40                     | 12,5                   | 14,0                     | ---                            | ---      | --- | ---        | € 994,00 |            |
|                       | MCY/157                 |                            | CI71                       |  |  |                    |                     |                      |                        |                          |                        |                          |                                |          |     |            |          |            |
|                       | MQN/157                 | Wengé<br>Wengé<br>wood     | CB76                       |  |  |                    |                     |                      |                        |                          |                        |                          |                                |          |     |            |          |            |
|                       | MQY/157                 |                            | CI71                       |  |  |                    |                     |                      |                        |                          |                        |                          |                                |          |     |            |          |            |
| POINT                 |                         | MC/191G                    | Ciliegio<br>Cherry<br>wood | 2-8                                    | 64   | 69                 | 121<br>112          | 59<br>50             | 1                      | 0,44                     | 14,3                   | 15,6                     | € 862,00                       | € 873,00 | --- | € 1.034,00 |          |            |
|                       |                         | MQ/191G                    | Wengé<br>Wengé<br>wood     |  |  |                    |                     |                      |                        |                          |                        |                          |                                |          |     |            |          |            |
|                       |                         |                            |                            |  |  |                    |                     |                      |                        |                          |                        |                          |                                |          |     |            |          |            |
|                       |                         | MC/191GO                   | Ciliegio<br>Cherry<br>wood | 2-6-8                                  | 64   | 69                 | 121<br>112          | 59<br>50             | 1                      | 0,44                     | 14,6                   | 15,9                     | € 895,00                       | € 907,00 | --- | € 1.068,00 |          |            |
|                       |                         | MQ/191GO                   | Wengé<br>Wengé<br>wood     |  |  |                    |                     |                      |                        |                          |                        |                          |                                |          |     |            |          |            |
|                       |                         |                            |                            |  |  |                    |                     |                      |                        |                          |                        |                          |                                |          |     |            |          |            |
|                       |                         | MC/193G                    | Ciliegio<br>Cherry<br>wood | 2-8                                    | 64   | 68                 | 101<br>92           | 59<br>50             | 1                      | 0,32                     | 12,0                   | 13,3                     | € 814,00                       | € 824,00 | --- | € 978,00   |          |            |
|                       |                         | MQ/193G                    | Wengé<br>Wengé<br>wood     |  |  |                    |                     |                      |                        |                          |                        |                          |                                |          |     |            |          |            |
|                       |                         |                            |                            |  |  |                    |                     |                      |                        |                          |                        |                          |                                |          |     |            |          |            |
|                       |                         | MC/193GO                   | Ciliegio<br>Cherry<br>wood | 2-6-8                                  | 64   | 68                 | 101<br>92           | 59<br>50             | 1                      | 0,32                     | 12,3                   | 13,6                     | € 847,00                       | € 857,00 | --- | € 1.011,00 |          |            |
|                       |                         |                            |                            |  |  |                    |                     |                      |                        |                          |                        |                          |                                |          |     |            |          |            |
|                       |                         |                            |                            |  |  |                    |                     |                      |                        |                          |                        |                          |                                |          |     |            |          |            |
|                       |                         |                            |                            |  |  |                    |                     |                      |                        |                          |                        |                          |                                |          |     |            |          |            |
| FUNZIONI<br>FUNCTIONS |                         |                            |                            |  |  |                    |                     |                      |                        |                          |                        |                          |                                |          |     |            |          |            |
|                       | IMPILABILE<br>STACKABLE | MOLOMATIC<br>MOLOMATIC     | GAS<br>GAS                 | SCHIENALE<br>REGOLABILE<br>BACK ADJUST | CONTATTO<br>PERMANENTE<br>PERMANENT<br>CONTACT | SYNCRON<br>SYNCRON | OSCILLANTE<br>SWING | SLITTA<br>FIXED FOOT | ALLUMINIO<br>ALUMINIUM | CROMO<br>CHROMIUM        | NYLON<br>NYLON         |                          |                                |          |     |            |          |            |

| LINEA<br>LINE | ARTICOLO<br>ARTICLE   |         | BRACCIOLI<br>ARMS          | CUOIO<br>THICK LEATHER | FUNZIONI<br>FUNCTIONS | DIMENSIONI<br>DIMENSIONS |    |           |          | COLLI<br>PACKINGS |      |             |             | PREZZO - PRICE - PRIX - PRECIO |                                    |                                  |                                    |                                     |  |
|---------------|---|---------|----------------------------|------------------------|-----------------------|--------------------------|----|-----------|----------|-------------------|------|-------------|-------------|--------------------------------|------------------------------------|----------------------------------|------------------------------------|-------------------------------------|--|
|               |   |         |                            |                        |                       |                          |    |           |          | N°<br>COLLI       | m³   | KG<br>NETTO | KG<br>LORDO | CAT. T<br>TREVIRA<br>TREVIRA   | CAT. M<br>MICROFIBRA<br>MICROFIBER | CAT. L<br>ALCANTARA<br>ALCANTARA | CAT. P<br>PELLE<br>THIN<br>LEATHER | CAT. C<br>CUOIO<br>THICK<br>LEATHER |  |
|               |   |         |                            |                        |                       |                          |    |           |          |                   |      |             |             |                                |                                    |                                  |                                    |                                     |  |
| POINT         |    | M/198G  |                            |                        | 1-7-8                 | 54                       | 68 | 101<br>92 | 59<br>50 | 1                 | 0,32 | 10,0        | 11,3        | € 611,00                       | € 622,00                           | ---                              | € 775,00                           |                                     |  |
|               |   | MC/199G | Ciliegio<br>Cherry<br>wood |                        | 1-7-8                 | 64                       | 68 | 101<br>92 | 59<br>50 | 1                 | 0,32 | 12,0        | 13,3        | € 815,00                       | € 827,00                           | ---                              | € 979,00                           |                                     |  |
|               |   | MQ/199G | Wengé<br>Wengé<br>wood     |                        |                       |                          |    |           |          |                   |      |             |             |                                |                                    |                                  |                                    |                                     |  |
|               |   |         |                            |                        |                       |                          |    |           |          |                   |      |             |             |                                |                                    |                                  |                                    |                                     |  |
|               |   |         |                            |                        |                       |                          |    |           |          |                   |      |             |             |                                |                                    |                                  |                                    |                                     |  |
|               |   |         |                            |                        |                       |                          |    |           |          |                   |      |             |             |                                |                                    |                                  |                                    |                                     |  |
|               |   |         |                            |                        |                       |                          |    |           |          |                   |      |             |             |                                |                                    |                                  |                                    |                                     |  |
|               |   |         |                            |                        |                       |                          |    |           |          |                   |      |             |             |                                |                                    |                                  |                                    |                                     |  |
|               |   |         |                            |                        |                       |                          |    |           |          |                   |      |             |             |                                |                                    |                                  |                                    |                                     |  |
|               |   |         |                            |                        |                       |                          |    |           |          |                   |      |             |             |                                |                                    |                                  |                                    |                                     |  |
| MP            |  | M/71    |                            |                        | ---                   | 61                       | 54 | 76        | 49       | 1                 | 0,30 | 15,0        | 16,5        | € 920,00                       | € 927,00                           | € 1.314,00                       | € 1.358,00                         |                                     |  |
|               |   | M/79    |                            |                        | ---                   | 82                       | 77 | 75        | 45       | 1                 | 0,69 | 22,0        | 24,5        | € 1.717,00                     | € 1.729,00                         | € 2.191,00                       | € 2.303,00                         |                                     |  |
|               |   | M/80    |                            |                        | ---                   | 174                      | 77 | 75        | 45       | 1                 | 1,42 | 38,0        | 41,9        | € 2.396,00                     | € 2.413,00                         | € 3.288,00                       | € 3.457,00                         |                                     |  |
|               |   |         |                            |                        |                       |                          |    |           |          |                   |      |             |             |                                |                                    |                                  |                                    |                                     |  |

FUNZIONI  
FUNCTIONS



0  
IMPILABILE  
STACKABLE



1  
MOLOMATIC  
MOLOMATIC



2  
GAS  
GAS



3  
SCHIENALE  
REGOLABILE  
BACK ADJUST



4  
CONTATTO  
PERMANENTE  
PERMANENT  
CONTACT



5  
SYNCRON  
SYNCRON



6  
OSCILLANTE  
SWING



7  
SLITTA  
FIXED FOOT



8  
ALLUMINIO  
ALUMINIUM



9  
CROMO  
CHROMIUM



10  
NYLON  
NYLON





## SCHEDA TECNICA COLLEZIONE MASTER POINT

### Scrivanie:

La struttura, registrabile in altezza, ha gambe indipendenti costruite in un robusto scatolato di lamiera d'acciaio, decapato e verniciato con polveri epossipoliestere polimerizzate in forno a 200°C. Composta da un'asta in lamiera stampata, la gamba, regolabile in altezza ogni cm tra i 680 e i 760 mm con due semplici viti, è collegata al piano da una robusta staffa. Sempre le gambe sono finite superiormente con una cuffia in cuoio cucita a punto sella, coordinata, volendo, con un frontale strutturale in multistrati di legno, conformato a semicerchio e rivestito anch'esso in cuoio cucito a punto sella. Il piano: è in legno da 30mm di spessore (costruito in MDF) e bisellato perimetralmente, impiallacciato in legno di ciliegio americano oppure in rovere tinto wengé, laccato a più mani con vernici poliuretaniche opache; oppure è in vetro temprato da 12 mm, satinato e rifinito con bordo a filo lucido su tutto il perimetro. La canalizzazione di serie prevede l'alloggiamento dei cavi in una canaletta fissata sotto il piano, mentre per la salita i cavi vengono raccolti in una gamba. Nelle scrivanie con i piani in vetro, è disponibile solo la salita dei cavi entro la gamba.

### Cassettiere:

Le cassettiere hanno il top bisellato in MDF ed i frontali in truciolare da 18mm il tutto impiallacciato in legno, mentre i fianchi, la base e lo schienale sono costruiti con pannelli, sempre con spessore 18mm, in nobilitato color alluminio bordato PVC. I cassetti completamente in metallo montano guide a scomparsa scorrevoli su rulli, per la versione schedario si utilizzano guide telescopiche ad estrazione totale, internamente sono predisposti all'utilizzo di divisori ed hanno le maniglie in cuoio cucito a punto sella. Le cassettiere sono provviste di serratura con chiusura simultanea di tutti i cassetti e sotto il top, nel vano del primo cassetto, si può montare un cassetto portacancelleria in plastica.

### Allunghi:

Versatili allunghi affiancano le scrivanie, sempre con il piano, le ante ed i frontali cassetto impiallacciati in legno. Strutturalmente si possono avere elementi di supporto in pannelli melaminici color alluminio, oppure gambe metalliche. Esiste la versione con gambe abbinata ad una cassetta strutturale, in ogni caso, quando a sostegno degli allunghi ci sono gambe metalliche, questi sono regolabili in altezza.

### Armadi e librerie:

Gli armadi hanno i fianchi ed i piani costruiti in uno scatolato di lamiera d'acciaio verniciata color alluminio, la base da 30mm e lo schienale da 18mm sono in nobilitato color alluminio bordato PVC; il top, bisellato e rinforzato, è in MDF da 18mm impiallacciato in legno. I ripiani interni sono in lamiera metallica verniciata.

Gli armadi poggiano su piedini registrabili dall'interno e sono predisposti all'unione laterale. Le porte (in truciolare da 18mm) impiallacciate in legno, vengono montate su cerniere con apertura a 110° e nella versione optional possono alloggiare la serratura con chiave. Le porte in vetro temprato hanno uno spessore di 5mm. I cassetti schedari montano un telaio in acciaio verniciato e scorrono su guide telescopiche a sfera. Per motivi di sicurezza, tutti gli armadi che alloggiavano i cassetti schedario devono essere fissati tra di loro (nel caso di multipli adiacenti) per mezzo delle viti in dotazione. Mentre se usati singolarmente devono essere assicurati ad una parete di sostegno. Sono disponibili librerie che hanno la struttura degli armadi ed utilizzano schermi e componenti in lamiera d'acciaio calandrata e verniciata; le mensole sono in vetro temprato da 8mm. Le angoliere montano porte in multistrati di legno rivestite in cuoio cucito a punto sella o in vetro temprato e satinato.

### Complementi:

Gli accessori sono costruiti in lamiera d'acciaio verniciato con polveri epossipoliestere e rivestiti in cuoio lavorato a mano con cucitura a punto sella. A catalogo sono disponibili opere grafiche su tela personalizzate olio e matita dall'artista Isabella Pers inserite entro una cornice in alluminio ricoperta in cuoio con cucitura a punto sella. Nel caso che il Cliente sia già in possesso di tele, è possibile costruire la relativa cornice su misura. Non solo il cuoio color naturale guarnisce gli accessori o le finiture di MASTER POINT, bensì tutta la serie di tinte cuoio delle collezioni CODUTTI, a richiesta, è disponibile per coordinare gli arredi.

### Poltrone in cuoio MASTER:

Hanno la scocca in multistrati con imbottitura in espanso indeformabile e sono rivestite in cuoio da 1,7-1,8mm di spessore lavorato a punto sella. Montano un meccanismo oscillante, con blocco in 6 posizioni. L'elevazione avviene tramite pompa a gas. La base è in alluminio verniciato a cinque razze, con ruote doppie piroettanti. I braccioli sono in legno massello laccato hanno struttura metallica in tubo verniciato. La versione visitatore ha la struttura fissa in tubo con diametro 25mm verniciato.

### Poltrone POINT:

Hanno la scocca in multistrati con imbottitura in espanso indeformabile e sono rivestite in tessuto od in pelle. Montano un meccanismo oscillante, con blocco in 1 posizione. L'elevazione avviene tramite pompa a gas. La base è in alluminio verniciato a cinque razze, con ruote doppie piroettanti. I braccioli sono in legno massello laccato hanno struttura metallica in tubo verniciato. La versione visitatore ha la struttura fissa in tubo ovale 36x18mm verniciato.

### Poltroncine e divani MP:

Sono costruiti con un telaio in acciaio, imbottiti con espanso indeformabile e rivestiti in tessuto od in pelle. I braccioli sono in tubo verniciato.

## MASTER POINT COLLECTION TECHNICAL SPECIFICATIONS

### Writing desks:

The height-adjustable structure of MASTER POINT desks disposes of independently-mounted legs made from sturdy box-type sheet steel, pickled and kiln-lacquered with polymerized epoxy-polyester at 200°C. The leg comprises a pressed sheet steel upright fixed to the desktop by means of a sturdy bracket and is adjustable every cm from 680mm to 760mm by means of two screws. Leg tops are finished with a saddle-stitched leather cap optionally combined with a structural modesty panel available in semicircular bent multilayered wood upholstered in saddle-stitched leather. The wood top in 30mm-thick MDF and has round-contoured edged. It is veneered in American cherry or wengé finished oak-wood and lacquered with several coats of matt-finish polyurethane varnish. The 12mm-thick toughened glass top has a satin finish and all-round bright filament edges. Standard cable housing is in a small channel mounted under the desktop. Cables are guided to the desktop along one of the legs. The leg-mounted cable channel only is available for glasstop desks.

### Drawer boxes:

Drawer boxes feature a contour-edged MDF top and front panels in 18mm-thick particleboard, all wood veneered. Sides, bases and backs are in 18mm-thick aluminium-colour melamine particleboard with PVC edging. All-metal drawers are fitted with roller-mounted sliding pull-out guides. Filing cabinets have fully extractable drawer guides and are designed to allow the use of internal partitions. Handles are in saddle-stitched leather. Drawer boxes are fitted with a simultaneous locking device that blocks all the drawers. A practical plastic stationery tray can also be fitted under the worktop in the space for the top drawer.

### Extensions:

Versatile extensions, with wood veneered top, doors and drawer fronts, complete the writing desks. Both supporting elements, constructed from aluminium coloured melamine panels, and metal legs are at disposal. The version with legs combined with a supporting drawer unit is also available; the extensions are anyway height-adjustable if they are supported by metal legs.

### Cabinets and bookcases:

Cabinet sides and shelves are in lacquered aluminium-coloured box-type sheet steel, the 30mm-thick base and the 18mm-thick back are in aluminium-coloured, PVC-edged, melamine particleboard. Cabinet tops, which are contour-edged and reinforced, are in 18mm-thick wood veneered MDF. The internal shelves are in lacquered metal sheet. Cabinets are supported on feet that can be adjusted from the interior and are designed to be connected laterally to each other. Doors in 18mm-thick wood veneer particleboard are mounted on hinges that open to 110°. The optional version can be fitted with a key-operated lock. The toughened glass doors are 5-mm thick. File drawers feature a lacquered steel frame and run on ball-mounted telescopic guides. For safety reasons all the cabinets equipped with filing drawers must be fixed each other (in case of adjoining multiple units) with the supplied screws, while if they are used separately they must be secured to a supporting wall. Cabinet-style bookcases are also available, incorporating screens and components in lacquered bent sheet steel. Shelves are in 8-mm thick toughened glass. Corner units have doors in multilayered wood covered with saddle-stitched leather or in toughened satin glass.

### Accessories:

Accessories are in epoxy-lacquered sheet steel upholstered in handmade saddle-stitched leather. As in the catalogue reported the collection comprises also oil and pencil graphic works signed one by one by the artist Isabella Pers, mounted in an aluminium frame covered with saddle-stitched leather. It is also possible to supply frames to measure, in case that the client already owns some pictures. To coordinate the components of MASTER POINT collection the accessories or finishes decoration is in leather, natural coloured but also coloured according to the leather teints of CODUTTI collections.

### MASTER leather armchairs:

Master chairs feature a multilayer shell padded with shape-retaining expanded polyurethane and upholstered in 1,7-1,8mm-thick saddle-stitched leather. They are fitted with a 6-position blockable rocking mechanism. Height is adjustable by means of a gas-action pump. The 5-spoke base is in lacquered aluminium, fitted with dual castors. Arms are in lacquered solid wood with a lacquered tubular metal structure. The visitor version has a lacquered 25mm-diameter tubular fixed structure.

### POINT armchairs:

Point chairs feature a multilayer shell padded with shape-retaining expanded polyurethane and are lined with fabric or leather. They are fitted with a 1-position blockable rocking mechanism. Height is adjustable by means of a gas-action pump. The 5-spoke base is in lacquered aluminium, fitted with dual castors. Arms are in lacquered solid wood with a lacquered tubular metal structure. The visitor version has a lacquered 36x18 mm oval tubular fixed structure.

### MP small armchairs and sofas:

They have a steel frame padded with shape-retaining expanded polyurethane and are covered with fabric or leather. Arms are in lacquered tubular metal.





## FICHE TECHNIQUE COLLECTION MASTER POINT

### **Bureaux:**

La structure est réglable en hauteur, avec piétements indépendants construits en tôle d'acier pliée en caisson, laquée avec poudres époxy polyester polymérisées au four à 200°C. Le piétement, réglable en hauteur tous les cm de 680 à 760mm à l'aide de deux vis, est composé d'un pied en tôle estampé assemblé au plateau par une solide platine. Les pieds présentent sur le dessus un embout en cuir cousu façon sellier. Les bureaux peuvent être équipés d'un voile de fond structurel en multiplis de bois cintré en demi-cercle et recouvert en cuir cousu façon sellier. Le plateau est en MDF de 30mm d'épaisseur avec chants profilés en "aile d'avion" sur tout le pourtour; il est plaqué en cerisier ou en bois the rouvre finition wengé, traité en surface avec plusieurs couches de vernis polyuréthane finition mate. Le plateau en verre trempé de 12mm est satiné avec arête polie sur tout le pourtour. Le chemin de câbles horizontal fourni de série prévoit le logement des câbles dans une gaine fixée sous le plateau tandis que la montée des câbles s'effectue à l'intérieur d'un des piétements. Dans les bureaux avec plateau en verre, seul le chemin de câbles à l'intérieur du piétement est disponible.

### **Caissons à tiroirs:**

Le dessus des caissons est en MDF avec chants profilés en "aile d'avion" et les façades sont en aggloméré de 18mm, le tout plaqué en bois tandis que les côtés, la base et le panneau arrière sont construits avec des panneaux de 18mm d'épaisseur avec finition mélaminée couleur aluminium et chants en PVC. Les tiroirs, entièrement en métal, sont munis de glissières à guidage escamotable sur rouleaux; dans la version classeur, les tiroirs sont munis de glissières télescopiques à extraction totale, ils sont prévus pour recevoir des séparations internes; les poignées sont en cuir cousu façon sellier. Les caissons sont munis de serrure avec fermeture simultanée de tous les tiroirs. Derrière la façade du premier tiroir, il est possible de monter un tiroir plumier en plastique.

### **Rallonges:**

Des rallonges adaptables, avec le dessus, les portes et les fronts des tiroirs plaqués en bois, complètent les bureaux. La structure peut disposer de éléments de support en panneaux mélaminés de couleur aluminium ou de pieds métalliques. Il y a aussi la version avec piétements assemblés avec un caisson de support; en tout cas si les rallonges sont soutenues par pieds métalliques, elles sont réglables en hauteur.

### **Armoires et bibliothèques:**

Les étagères et les côtés des armoires sont construits en tôle d'acier pliée en caisson et laquée couleur aluminium; la base de 30mm et le panneau arrière de 18mm sont en mélaminé couleur aluminium avec chants en PVC tandis que le dessus, renforcé, avec chants profilés en "aile d'avion" est en MDF de 18mm plaqué en bois. Les étagères internes sont disponibles en tôle métallique laquée. Les armoires reposent sur des vérins réglables de l'intérieur et sont prévues pour la jonction latérale. Les portes (en aggloméré de 18mm) plaquées en bois sont montées sur charnières avec ouverture à 110° et en option elles peuvent être munies de serrure avec clé. Les portes en verre trempé ont une épaisseur de 5mm. Les tiroirs classeurs sont équipés d'un châssis en acier laqué et coulissent sur des glissières télescopiques avec guidage à billes. Pour raisons de sécurité toutes les armoires dotées de tiroirs fichier doivent être fixés entre eux (en cas de multiples adjacents) avec les vis fournies, tandis que s'elles sont utilisées individuellement elles doivent être assurées à une cloison de support. Le programme comprend également des bibliothèques qui possèdent la même structure que les armoires et utilisent des panneaux-écrans et des composants en tôle d'acier ceintrée et laquée; les étagères sont en verre trempé de 8mm. Les éléments d'angle sont équipés de portes en multiplis recouvertes de cuir cousu façon sellier ou en verre trempé satiné.

### **Compléments:**

Les accessoires sont en tôle d'acier laquée avec poudres époxy polyester et recouverts en cuir cousu main façon sellier. Le catalogue propose aussi des oeuvres graphiques à l'huile et au crayon sur toile, personnalisées une à une par l'artiste Isabella Pers et montées dans un cadre en aluminium revêtu en cuir cousu façon sellier. Si le client possède déjà des toiles on peut construire le cadre sur mesure. Les accessoires ou les finitions de MASTER POINT sont décorés pas seulement en cuir de couleur naturel mais, sur demande, en la série complète de teintes cuir des collections CODUTTI, ainsi de assortir l'ameublement.

### **Fauteuils en cuir MASTER:**

Ils ont la coque en multiplis avec rembourrage en mousse expansée indéformable et sont revêtus en cuir de 1,7-1,8mm d'épaisseur cousu façon sellier. Ils sont équipés d'un mécanisme oscillant, avec blocage en six positions. Le réglage en hauteur est assuré par un verin à gaz. Le piétement est en aluminium laqué, à cinq branches, avec doubles roulettes pivotantes. Les accoudoirs sont en bois massif verni avec structure métallique en tube laqué. La version visiteur a une structure fixe en tube laqué de 25mm de diamètre.

### **Fauteuils POINT:**

Ils ont la coque en multiplis avec rembourrage en mousse expansée indéformable et sont revêtus en tissu ou cuir. Ils sont équipés d'un mécanisme oscillant, avec blocage en 1 position. Le réglage en hauteur est assuré par un verin à gaz. Le piétement est en aluminium laqué, à cinq branches, avec doubles roulettes pivotantes. Les accoudoirs sont en bois massif verni avec structure métallique en tube laqué. La version visiteur a une structure fixe en tube laqué ovale 36x18mm.

### **Petits fauteuils et sofas MP:**

Ils sont construits avec une structure portante en acier, rembourrés avec de la mousse expansée indéformable et revêtus de tissu ou de cuir. Les accoudoirs sont en tube laqué.

## FICHA TÉCNICA COLECCIÓN MASTER POINT

### **Escritorios:**

Se puede regular la altura de la estructura, las patas son independientes, construidas en robusto perfil tubular rectangular en chapa de acero decapado y pintado, con polvos epoxi-poliéster polimerizados a 200°C. La pata está compuesta por una barra en chapa moldeada, se puede regular su altura un centímetro por vez, entre 680 y 760 mm con dos simples tornillos y está unida al plano mediante una robusta abrazadera. Las patas están acabadas en la parte superior con un elemento de cobertura en cuero respunteado. Dispone de un faldón estructural multilaminar de madera, postformado en semicircunferencia y revestido de cuero, con costuras respunteadas. La tapa de madera de 30 mm de espesor (construida en MDF) está achaflanada perimetralmente, chapeada en madera de cerezo americano o bien en madera de roble encabado wengé, lacada con varias capas de pinturas poliuretánicas mate. La tapa de vidrio templado de 12 mm es satinada y terminada con canto brillante en todo el perímetro. Los canales de electrificación de serie alojan los cables dentro de una canaleta fijada debajo de la tapa, mientras para la subida los cables se agrupan en una pata. En los escritorios con las tapas de vidrio se dispone solamente de la subida de los cables en el interior de la pata.

### **Cajoneras:**

Las tapas de las cajoneras son achaflanadas en MDF y los paneles delanteros en aglomerado de 18 mm, chapeados de madera, mientras los costados, la base y la trasera están construidos con tableros siempre de 18 mm de grosor, en tablero melamínico color aluminio, rebordados de PVC. Los cajones completamente de metal están equipados con guías de rodamiento deslizables, para la versión archivador se utilizan guías telescópicas de extracción total, interiormente están provistas de divisores y tienen manijas en cuero respunteado. Las cajoneras están equipadas con cerradura con cierre simultáneo de todos los cajones; debajo de la tapa, en el vano del primer cajón, se puede montar un cajón de plástico para guardar el material de oficina.

### **Extensiones:**

Las extensiones versátiles complementan los mostradores, siempre con tableros, puertas y paneles frontales de los cajones enchapados en madera. Estructuralmente puede proponer elementos de soporte en paneles melamínicos de color aluminio o también patas metálicas. Existe la versión con patas combinadas a una cajonera estructural; las patas metálicas que sostienen las extensiones son de altura regulable.

### **Armarios y bibliotecas:**

Los costados y las tapas de los armarios están construidos en perfil tubular rectangular, en chapa de acero pintada de color aluminio, la base de 30 mm y la trasera de 18 mm son en tablero melamínico color aluminio, rebordado en PVC; mientras la tapa, achaflanada y reforzada es en MDF de 18 mm, chapeada en madera. Los estantes internos son en chapa metálica lacada. Los armarios se apoyan sobre patas ajustables desde la parte interna y están predisuestos para la unión lateral. Las puertas (en aglomerado de 18 mm) chapeadas en madera, están montadas sobre bisagras con apertura a 110°, y en la versión opcional pueden alojar la cerradura con llave. Las puertas de vidrio templado tienen un grosor de 5 mm. Los cajones para archivadores montan un armazón de acero pintado y se deslizan sobre guías telescópicas de bolas. Por razones de seguridad, todos los armarios que alojan cajones ficheros deben ser fijados entre sí (en el caso de múltiples adyacentes) usando los tornillos entregados con los equipos. Si se usan de forma individual es necesario fijarlos a una pared de sostén. Se dispone también de bibliotecas con la misma estructura de los armarios y utilizan paneles separadores y componentes en lámina de acero calandrada y pintada; los estantes son de vidrio templado de 8 mm. Los esquineros están equipados con puertas en multilaminar de madera, revestidas en cuero con costuras respunteadas o en vidrio templado satinado.

### **Accesorios:**

Los accesorios están construidos en chapa de acero pintado con polvos epoxi-poliéster y recubiertos en cuero trabajado a mano con costuras respunteadas. En el catálogo se ilustran las obras gráficas sobre tela, personalizadas en óleo y lápiz, de la artista Isabella Pers, con marco en aluminio recubierto en cuero con costuras respunteadas. Si el cliente posee ya telas de valor, es posible construir el marco a medida. Los accesorios y los acabados de la serie MASTER RECEPTION están embellecidos no sólo con cuero natural sino también con todas las tonalidades de cuero de las colecciones CODUTTI, disponibles bajo demanda para coordinar todas las decoraciones de interiores.

### **Sillones de cuero MASTER:**

El armazón es estratificado con rellenos en espuma indeformable, tapizado en cuero de 1,7-1,8 mm de espesor, con costuras respunteadas. Están equipados con mecanismo oscilante, con bloqueo en 1 posición. La elevación se realiza mediante pistón a gas. La base de apoyo pentagonal es de aluminio pintado y está equipada con ruedas dobles pivotantes. Los apoyabrazos son de madera maciza lacada y poseen estructura metálica en tubo pintado. La versión visitante tiene la misma estructura fija en tubo con diámetro de 25 mm, siempre pintado.

### **Sillones POINT:**

El armazón es estratificado con rellenos en espuma indeformable, tapizado en tejido o piel. Están equipados con mecanismo oscilante, con bloqueo en una posición. La elevación se realiza mediante pistón a gas. La base de apoyo pentagonal es de aluminio pintado y está equipada con ruedas dobles pivotantes. Los apoyabrazos son de madera maciza lacada y poseen estructura metálica en tubo pintado. La versión visitante tiene la estructura fija en tubo ovalado de 36x18 mm pintado.

### **Butacas y sofás MP:**

Están construidos con un armazón de acero, revestidos con espuma de poliuretano indeformable y tapizados con telas o piel. Los apoyabrazos son en tubo pintado.



# ***NOTES***



# **LISTINO PREZZI**

## **MASTER LINE**

**In questo listino sono presenti i nuovi articoli della linea MASTER LINE.  
Per completare l'offerta sul listino MASTER POINT sono disponibili:  
gli allunghi mobili, le cassettiere, gli accessori, del mondo MASTER.**

***In this price list are introduced new items of MASTER LINE collection.  
Mobile extensions, drawer units and accessories of MASTER world are  
available on MASTER POINT price list completing our offer.***

MASTER LINE - V2.0

| SCRIVANIE CON TOP LEGNO<br>WRITING DESK WITH WOOD TOP |                                 |   |                            |  |   |                            |  |
|---|---------------------------------|---|----------------------------|--|---|----------------------------|--|
| DISEGNO<br>DRAWING                                    | DIMENSIONI<br>DIMENSIONS<br>Cm. | TOP LEGNO CILIEGIO MC04<br>CHERRY MC04 WOOD TOP   |                            |  | TOP LEGNO WENGE' SW06<br>WENGE' SW06 WOOD TOP       |                            |  |
|   |                                 | CUOIO FINITURE GAMBE<br>LEGS FINISHES THICK LEATHER   |                            |  | CUOIO FINITURE GAMBE<br>LEGS FINISHES THICK LEATHER |                            |  |
|   | PACKING LIST                    | NATURALE<br>NATURAL<br>CB76   | MOKA<br>MOKA<br>CM81       |  | NATURALE<br>NATURAL<br>CB76                         | MOKA<br>MOKA<br>CM81       |  |
|   | COLLI packages<br>N°3           | Scrivania registrabile con finiture in cuoio e top rettangolare in legno<br><i>Adjustable writing desk with leather linings and rectangular wood top</i>  |                            |  |   |                            |  |
|   | 180X100X72H<br>Mc.<br>Kg.       | MCN / 180<br>€ 1.943,00   | MCM / 180<br>€ 1.943,00    |  | MQN / 180<br>€ 1.943,00                             | MQM / 180<br>€ 1.943,00    |  |
|   | 200X100X72H<br>Mc.<br>Kg.       | MCN / 200<br>€ 2.049,00   | MCM / 200<br>€ 2.049,00    |  | MQN / 200<br>€ 2.049,00                             | MQM / 200<br>€ 2.049,00    |  |
|   | 220X100X72H<br>Mc.<br>Kg.       | MCN / 220<br>€ 2.154,00   | MCM / 220<br>€ 2.154,00    |  | MQN / 220<br>€ 2.154,00                             | MQM / 220<br>€ 2.154,00    |  |
|   | COLLI packages<br>N°5           | Scrivania con schienale lineare rivestito in cuoio e top rettangolare in legno<br><i>Writing desk with leather straight modesty panel and rectangular wood top</i>  |                            |  |   |                            |  |
|   | 180X100X72H<br>Mc.<br>Kg.       | MCN / 180L<br>€ 2.695,00  | MCM / 180L<br>€ 2.695,00   |  | MQN / 180L<br>€ 2.695,00                            | MQM / 180L<br>€ 2.695,00   |  |
|   | 200X100X72H<br>Mc.<br>Kg.       | MCN / 200L<br>€ 2.800,00  | MCM / 200L<br>€ 2.800,00   |  | MQN / 200L<br>€ 2.800,00                            | MQM / 200L<br>€ 2.800,00   |  |
|   | 220X100X72H<br>Mc.<br>Kg.       | MCN / 220L<br>€ 2.905,00  | MCM / 220L<br>€ 2.905,00   |  | MQN / 220L<br>€ 2.905,00                            | MQM / 220L<br>€ 2.905,00   |  |
|   | COLLI packages<br>N°5           | Scrivania registrabile con finiture in cuoio e top in legno più penisola di conversazione utilizzabile a dx e a sx<br><i>Adjustable writing desk with leather linings, wood top and conversation area usable on left or right side</i>  |                            |  |   |                            |  |
|   | 280X100X72H<br>Mc.<br>Kg.       | MCN / 180CR<br>€ 3.588,00   | MCM / 180CR<br>€ 3.588,00  |  | MQN / 180CR<br>€ 3.588,00                           | MQM / 180CR<br>€ 3.588,00  |  |
|   | 300X100X72H<br>Mc.<br>Kg.       | MCN / 200CR<br>€ 3.694,00   | MCM / 200CR<br>€ 3.694,00  |  | MQN / 200CR<br>€ 3.694,00                           | MQM / 200CR<br>€ 3.694,00  |  |
|   | 320X100X72H<br>Mc.<br>Kg.       | MCN / 220CR<br>€ 3.798,00   | MCM / 220CR<br>€ 3.798,00  |  | MQN / 220CR<br>€ 3.798,00                           | MQM / 220CR<br>€ 3.798,00  |  |
|   | COLLI packages<br>N°7           | Scrivania con schienale lineare rivestito in cuoio e top in legno più penisola di conversazione utilizzabile a dx e a sx<br><i>Writing desk with leather linings, wood top and conversation area usable on left or right side</i>   |                            |  |   |                            |  |
|   | 280X100X72H<br>Mc.<br>Kg.       | MCN / 180CRL<br>€ 4.339,00  | MCM / 180CRL<br>€ 4.339,00 |  | MQN / 180CRL<br>€ 4.339,00                          | MQM / 180CRL<br>€ 4.339,00 |  |
|   | 300X100X72H<br>Mc.<br>Kg.       | MCN / 200CRL<br>€ 4.445,00  | MCM / 200CRL<br>€ 4.445,00 |  | MQN / 200CRL<br>€ 4.445,00                          | MQM / 200CRL<br>€ 4.445,00 |  |
|   | 320X100X72H<br>Mc.<br>Kg.       | MCN / 220CRL<br>€ 4.549,00  | MCM / 220CRL<br>€ 4.549,00 |  | MQN / 220CRL<br>€ 4.549,00                          | MQM / 220CRL<br>€ 4.549,00 |  |
|   | COLLI packages<br>N°3           | Scrivania con finiture in cuoio e top in legno predisposta al montaggio del mobile servizio in legno utilizzabile a dx e a sx<br><i>Writing desk with leather linings, wood top and conversation area drew up in advance for the assembly of the credenza usable on left or right side</i>    |                            |  |   |                            |  |
|   | 180X220X72H<br>Mc.<br>Kg.       | MCN / 180P<br>€ 1.581,00  | MCM / 180P<br>€ 1.581,00   |  | MQN / 180P<br>€ 1.581,00                            | MQM / 180P<br>€ 1.581,00   |  |
|   | 200X220X72H<br>Mc.<br>Kg.       | MCN / 200P<br>€ 1.687,00  | MCM / 200P<br>€ 1.687,00   |  | MQN / 200P<br>€ 1.687,00                            | MQM / 200P<br>€ 1.687,00   |  |
|   | 220X220X72H<br>Mc.<br>Kg.       | MCN / 220P<br>€ 1.791,00  | MCM / 220P<br>€ 1.791,00   |  | MQN / 220P<br>€ 1.791,00                            | MQM / 220P<br>€ 1.791,00   |  |
|   | COLLI packages<br>N°5           | Scrivania con schienale rivestito in cuoio e top in legno predisposta al montaggio mobile servizio utilizz. a dx e a sx<br><i>Writing desk with straight modesty panel having leather covering. Wood top drew up in advance for the assembly of the credenza usable on left or right side</i> |                            |  |   |                            |  |
|   | 180X220X72H<br>Mc.<br>Kg.       | MCN / 180PL<br>€ 2.332,00   | MCM / 180PL<br>€ 2.332,00  |  | MQN / 180PL<br>€ 2.332,00                           | MQM / 180PL<br>€ 2.332,00  |  |
|   | 200X220X72H<br>Mc.<br>Kg.       | MCN / 200PL<br>€ 2.438,00   | MCM / 200PL<br>€ 2.438,00  |  | MQN / 200PL<br>€ 2.438,00                           | MQM / 200PL<br>€ 2.438,00  |  |
|   | 220X220X72H<br>Mc.<br>Kg.       | MCN / 220PL<br>€ 2.542,00   | MCM / 220PL<br>€ 2.542,00  |  | MQN / 220PL<br>€ 2.542,00                           | MQM / 220PL<br>€ 2.542,00  |  |

**MASTER LINE - V2.0**

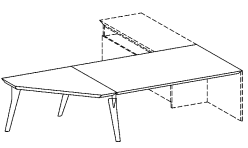
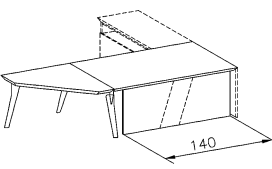
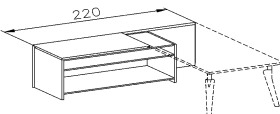
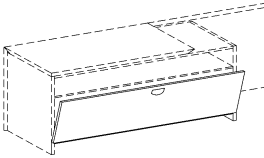
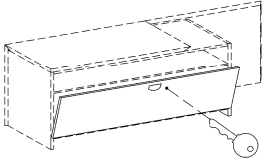
| SCRIVANIE CON TOP LEGNO<br>WRITING DESK WITH WOOD TOP                              |                                 |  |                            |  |  |                            |  |
|--|---------------------------------|--|----------------------------|--|--|----------------------------|--|
| DISEGNO<br>DRAWING   | DIMENSIONI<br>DIMENSIONS<br>Cm. | TOP LEGNO CILIEGIO MC04<br>CHERRY MC04 WOODEN TOP  |                            |  | TOP LEGNO WENGÉ' SW06<br>WENGÉ' SW06 WOODEN TOP                        |                            |  |
|  |                                 | CUOIO FINITURE GAMBE<br>LEGS FINISHES THICK LEATHER  |                            |  | CUOIO FINITURE GAMBE<br>LEGS FINISHES THICK LEATHER                    |                            |  |
|  | PACKING LIST                    | NATURALE<br>NATURAL<br>CB76  | MOKA<br>MOKA<br>CM81       |  | NATURALE<br>NATURAL<br>CB76  | MOKA<br>MOKA<br>CM81       |  |
|    | COLLI packages<br>N°5           | Scrivania con top in legno predisposta al montaggio del mobile servizio in legno più penisola di convers. utilizz. a dx e a sx<br><i>Writing desk with wood top drew up in advance for the assembly of the wood credenza usable on left or right side</i>  |                            |  |  |                            |  |
|  | 280X220X72H<br>Mc.<br>Kg.       | MCN / 180PCR<br>€3.225,00  | MCM / 180PCR<br>€3.225,00  |  | MQN / 180PCR<br>€3.225,00  | MQM / 180PCR<br>€3.225,00  |  |
|  | 300X100X72H<br>Mc.<br>Kg.       | MCN / 200PCR<br>€3.331,00  | MCM / 200PCR<br>€3.331,00  |  | MQN / 200PCR<br>€3.331,00  | MQM / 200PCR<br>€3.331,00  |  |
|  | 320X100X72H<br>Mc.<br>Kg.       | MCN / 220PCR<br>€3.435,00  | MCM / 220PCR<br>€3.435,00  |  | MQN / 220PCR<br>€3.435,00  | MQM / 220PCR<br>€3.435,00  |  |
|    | COLLI packages<br>N°7           | Scriv. con schienale rivestito in cuoio con top in legno predis. al montaggio mobile servizio più penisola di convers. utilizz. a dx e a sx<br><i>Writing desk with straight modesty panel having leather covering. Wood top drew up in advance for the assembly of the credenza usable on left or right side.</i> |                            |  |  |                            |  |
|  | 280X220X72H<br>Mc.<br>Kg.       | MCN / 180PCRL<br>€3.976,00   | MCM / 180PCRL<br>€3.976,00 |  | MQN / 180PCRL<br>€3.976,00   | MQM / 180PCRL<br>€3.976,00 |  |
|  | 300X100X72H<br>Mc.<br>Kg.       | MCN / 200PCRL<br>€4.082,00   | MCM / 200PCRL<br>€4.082,00 |  | MQN / 200PCRL<br>€4.082,00   | MQM / 200PCRL<br>€4.082,00 |  |
|  | 320X100X72H<br>Mc.<br>Kg.       | MCN / 220PCRL<br>€4.187,00   | MCM / 220PCRL<br>€4.187,00 |  | MQN / 220PCRL<br>€4.187,00   | MQM / 220PCRL<br>€4.187,00 |  |
| DISEGNO<br>DRAWING   | DIMENSIONI<br>DIMENSIONS<br>Cm. | INDICARE IL COLORE STRUTTURA CAMBIANDO LA LETTERA "?" CON : A = ALLUMINIO; E = NERO<br><i>INDICATE THE COLOR OF THE STRUCTURE CHANGING LETTER "?" WITH : A = ALUMINIUM; E = BLACK</i>  |                            |  |  |                            |  |
|  |                                 | TOP E SCHIENALI IN CILIEGIO<br>CHERRY MC04 WOODEN TOP AND MODESTY PANELS   |                            |  | TOP E SCHIENALI IN WENGÉ'<br>WENGÉ' SW06 WOODEN TOP AND MODESTY PANELS |                            |  |
|  | PACKING LIST                    | NATURALE<br>NATURAL<br>CB76  | MOKA<br>MOKA<br>CM81       |  | NATURALE<br>NATURAL<br>CB76  | MOKA<br>MOKA<br>CM81       |  |
|  | COLLI packages<br>N°3           | Mobile servizio senza ante con struttura melaminica, top e schienali in legno da montare con le scrivanie predisposte<br><i>Service furniture having melamine structure without doors to be assembled with drew up writing desks</i>   |                            |  |  |                            |  |
|  | 120X60X72H<br>Mc.<br>Kg.        | M?CN / 120MS<br>€2.284,00  | M?CM / 120MS<br>€2.284,00  |  | M?QN / 120MS<br>€2.284,00  | M?QM / 120MS<br>€2.284,00  |  |
| DISEGNO<br>DRAWING   | DIMENSIONI<br>DIMENSIONS<br>Cm. | ANTA LEGNO CILIEGIO MC04<br>CHERRY MC04 WOODEN DOOR  |                            |  | ANTA LEGNO WENGÉ' SW06<br>WENGÉ' SW06 WOODEN DOOR                      |                            |  |
|  |                                 | CUOIO MANIGLIE<br>LEATHER HANDLES  |                            |  | CUOIO MANIGLIE<br>LEATHER HANDLES                                      |                            |  |
|  | PACKING LIST                    | NATURALE<br>NATURAL<br>CB76  | MOKA<br>MOKA<br>CM81       |  | NATURALE<br>NATURAL<br>CB76  | MOKA<br>MOKA<br>CM81       |  |
|  | COLLI packages<br>N°2           | Anta singola a ribalta in legno per mobile servizio ( si possono montare una per ogni mobile servizio )<br><i>Single drop-leaf wood door for credenza (can be assembled one for each credenza)</i>   |                            |  |  |                            |  |
|  | 170X1,9X28H<br>Mc.<br>Kg.       | MCN / POMS<br>€686,00  | MCM / POMS<br>€686,00      |  | MQN / POMS<br>€686,00  | MQM / POMS<br>€686,00      |  |
|  | COLLI packages<br>N°2           | Anta singola a ribalta in legno per mobile servizio con serratura ( si possono montare una per ogni mobile servizio )<br><i>Single drop-leaf wood door with lock for credenza (can be assembled one for each credenza)</i>   |                            |  |  |                            |  |
|  | 170X1,9X28H<br>Mc.<br>Kg.       | MCN / POMSS<br>€831,00   | MCM / POMSS<br>€831,00     |  | MQN / POMSS<br>€831,00   | MQM / POMSS<br>€831,00     |  |

**MASTER LINE - V2.0**

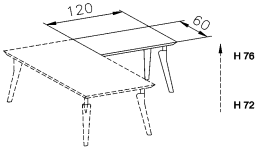
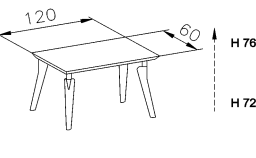
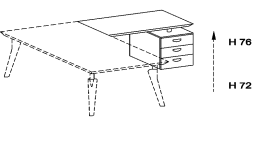
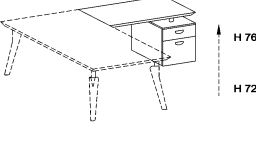
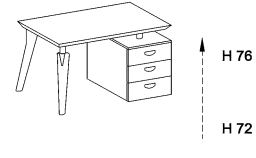
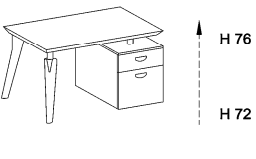

| SCRIVANIE CON TOP LEGNO<br>WRITING DESK WITH WOOD TOP                              |                                 |  |                              |  |   |                              |  |
|--|---------------------------------|--|------------------------------|--|---|------------------------------|--|
| DISEGNO<br>DRAWING   | DIMENSIONI<br>DIMENSIONS<br>Cm. | TOP LEGNO CILIEGIO MC04<br>CHERRY MC04 WOODEN TOP  |                              |  | TOP LEGNO WENGHE' SW06<br>WENGHE' SW06 WOODEN TOP                         |                              |  |
|  |                                 | CUOIO FINITURE GAMBE<br>LEGS FINISHES THICK LEATHER  |                              |  | CUOIO FINITURE GAMBE<br>LEGS FINISHES THICK LEATHER                       |                              |  |
|  | PACKING LIST                    | NATURALE<br>NATURAL<br>CB76  | MOKA<br>MOKA<br>CM81         |  | NATURALE<br>NATURAL<br>CB76   | MOKA<br>MOKA<br>CM81         |  |
|    | COLLI packages<br>N°3           | Allungo registrabile collegabile alle scrivanie di pag. 4 con top in legno<br><i>Adjustable extension with wood top connectable with the writing desks of page 4</i>   |                              |  |   |                              |  |
|  | 120X60X72H<br>Mc.<br>Kg.        | MCN / 120RE<br>€1.052,00   | MCM / 120RE<br>€1.052,00     |  | MQN / 120RE<br>€1.052,00  | MQM / 120RE<br>€1.052,00     |  |
|  |                                 |  |                              |  |   |                              |  |
|    | COLLI packages<br>N°3           | Allungo registrabile autonomo dalla scrivania con top in legno<br><i>Adjustable independent extension with wood top.</i>   |                              |  |   |                              |  |
|  | 120X60X72H<br>Mc.<br>Kg.        | MCN / 120REA<br>€1.432,00  | MCM / 120REA<br>€1.432,00    |  | MQN / 120REA<br>€1.432,00   | MQM / 120REA<br>€1.432,00    |  |
|  |                                 |  |                              |  |   |                              |  |
| DISEGNO<br>DRAWING   | DIMENSIONI<br>DIMENSIONS<br>Cm. | INDICARE IL COLORE STRUTTURA CAMBIANDO LA LETTERA "?" CON : A = ALLUMINIO; E = NERO<br><i>INDICATE THE COLOR OF THE STRUCTURE CHANGING LETTER "?" WITH : A = ALUMINIUM; E = BLACK</i>  |                              |  |   |                              |  |
|  |                                 | TOP E FRONTALI LEGNO CILIEGIO MC04<br>CHERRY WOOD TOPS AND FRONTAL PANELS  |                              |  | TOP E FRONTALI LEGNO WENGHE' SW06<br>WENGHE' WOOD TOPS AND FRONTAL PANELS |                              |  |
|  | PACKING LIST                    | NATURALE<br>NATURAL<br>CB76  | MOKA<br>MOKA<br>CM81         |  | NATURALE<br>NATURAL<br>CB76   | MOKA<br>MOKA<br>CM81         |  |
|  | COLLI packages<br>N°3           | Allungo registrabile collegabile alle scrivanie di pag. 4 con cassetiera in melaminico a 3 cassetti e top in legno<br><i>Adjustable extension connectable with the writing desks of page 4 including also a melamine drawer unit and wood top</i>                      |                              |  |   |                              |  |
|  | 120X60X72H<br>Mc.<br>Kg.        | M?CN / 120RE31<br>€2.007,00  | M?CM / 120RE31<br>€2.007,00  |  | M?QN / 120RE31<br>€2.007,00   | M?QM / 120RE31<br>€2.007,00  |  |
|  |                                 |  |                              |  |   |                              |  |
|  | COLLI packages<br>N°3           | Allungo registrabile collegabile alle scrivanie di pag. 4 con cassetiera in melaminico a 1 cassetto più schedario e top in legno<br><i>Adjustable extension connectable with the writing desks of page 4 including also a melamine filing drawer unit and wood top</i> |                              |  |   |                              |  |
|  | 120X60X72H<br>Mc.<br>Kg.        | M?CN / 120RE33<br>€1.949,00  | M?CM / 120RE33<br>€1.949,00  |  | M?QN / 120RE33<br>€1.949,00   | M?QM / 120RE33<br>€1.949,00  |  |
|  |                                 |  |                              |  |   |                              |  |
|  | COLLI packages<br>N°3           | Allungo registrabile autonomo dalla scrivania con cassetiera in melaminico a 3 cassetti e top in legno<br><i>Independent adjustable extension with melamine 3 drawers unit and wood top</i>  |                              |  |   |                              |  |
|  | 120X60X72H<br>Mc.<br>Kg.        | M?CN / 120RE31A<br>€2.389,00   | M?CM / 120RE31A<br>€2.389,00 |  | M?QN / 120RE31A<br>€2.389,00  | M?QM / 120RE31A<br>€2.389,00 |  |
|  |                                 |  |                              |  |   |                              |  |
|  | COLLI packages<br>N°3           | Allungo registrabile autonomo dalla scrivania con cassetiera in melaminico a 1 cassetto più schedario e top in legno<br><i>Independent adjustable extension with melamine filing drawer unit and wood top</i>  |                              |  |   |                              |  |
|  | 120X60X72H<br>Mc.<br>Kg.        | M?CN / 120RE33A<br>€2.331,00   | M?CM / 120RE33A<br>€2.331,00 |  | M?QN / 120RE33A<br>€2.331,00  | M?QM / 120RE33A<br>€2.331,00 |  |
|  |                                 |  |                              |  |   |                              |  |



MASTER LINE - V2.0

| ALLUNGHI CON TOP VETRO<br>EXTENSIONS WITH GLASS TOP |                                 |   |                             |  |   |                             |  |
|---|---------------------------------|---|-----------------------------|--|---|-----------------------------|--|
| DISEGNO<br>DRAWING                                  | DIMENSIONI<br>DIMENSIONS<br>Cm. | TOP VETRO SATINATO VS67<br>SATINED GLASS TOP VS67   |                             |  | TOP VETRO LACCATO MOKA VM71<br>LACQUERED MOKA GLASS TOP MOKA VM71 |                             |  |
|   |                                 | CUOIO FINITURE GAMBE<br>LEGS FINISHES THICK LEATHER   |                             |  | CUOIO FINITURE GAMBE<br>LEGS FINISHES THICK LEATHER               |                             |  |
|   | PACKING LIST                    | NATURALE<br>NATURAL<br>CB76   | MOKA<br>MOKA<br>CM81        |  | NATURALE<br>NATURAL<br>CB76                                       | MOKA<br>MOKA<br>CM81        |  |
|   | COLLI packages<br>N°3           | Scrivania registrabile con finiture in cuoio e top rettangolare in vetro temperato<br><i>Adjustable writing desk with leather linings and rectangular tempered glass top</i>  |                             |  |   |                             |  |
|   | 180X100X72H<br>Mc.<br>Kg.       | MSN / VS180<br>€2.734,00  | MSM / VS180<br>€2.734,00    |  | MMN / VP180<br>€2.734,00  | MMM / VP180<br>€2.734,00    |  |
|   | 200X100X72H<br>Mc.<br>Kg.       | MSN / VS200<br>€2.813,00  | MSM / VS200<br>€2.813,00    |  | MMN / VP200<br>€2.813,00  | MMM / VP200<br>€2.813,00    |  |
|   | 220X100X72H<br>Mc.<br>Kg.       | MSN / VS220<br>€2.931,00  | MSM / VS220<br>€2.931,00    |  | MMN / VP220<br>€2.931,00  | MMM / VP220<br>€2.931,00    |  |
|   | COLLI packages<br>N°5           | Scrivania con schienale dritto rivestito in cuoio e top rettangolare in vetro temperato<br><i>Writing desk with straight modesty covered by leather and rectangular tempered glass top</i>  |                             |  |   |                             |  |
|   | 180X100X72H<br>Mc.<br>Kg.       | MSN / VS180L<br>€3.441,00   | MSM / VS180L<br>€3.441,00   |  | MMN / VP180L<br>€3.441,00   | MMM / VP180L<br>€3.441,00   |  |
|   | 200X100X72H<br>Mc.<br>Kg.       | MSN / VS200L<br>€3.565,00   | MSM / VS200L<br>€3.565,00   |  | MMN / VP200L<br>€3.565,00   | MMM / VP200L<br>€3.565,00   |  |
|   | 220X100X72H<br>Mc.<br>Kg.       | MSN / VS220L<br>€3.682,00   | MSM / VS220L<br>€3.682,00   |  | MMN / VP220L<br>€3.682,00   | MMM / VP220L<br>€3.682,00   |  |
|   | COLLI packages<br>N°5           | Scrivania registrabile con finiture in cuoio e top in vetro temperato più penisola di conversazione utilizzabile a dx e a sx<br><i>Adjustable writing desk with leather linings and rectangular tempered glass top including conversation area usable on left or right side</i>               |                             |  |   |                             |  |
|   | 280X100X72H<br>Mc.<br>Kg.       | MSN / VS180CR<br>€4.334,00  | MSM / VS180CR<br>€4.334,00  |  | MMN / VP180CR<br>€4.334,00  | MMM / VP180CR<br>€4.334,00  |  |
|   | 300X100X72H<br>Mc.<br>Kg.       | MSN / VS200CR<br>€4.458,00  | MSM / VS200CR<br>€4.458,00  |  | MMN / VP200CR<br>€4.458,00  | MMM / VP200CR<br>€4.458,00  |  |
|   | 320X100X72H<br>Mc.<br>Kg.       | MSN / VS220CR<br>€4.575,00  | MSM / VS220CR<br>€4.575,00  |  | MMN / VP220CR<br>€4.575,00  | MMM / VP220CR<br>€4.575,00  |  |
|   | COLLI packages<br>N°7           | Scrivania con schienale dritto rivestito in cuoio e top in vetro temperato più penisola di conversazione utilizzabile a dx e a sx<br><i>Writing desk with straight modesty covered by leather and rectangular tempered glass top including conversation area usable on left or right side</i> |                             |  |   |                             |  |
|   | 280X100X72H<br>Mc.<br>Kg.       | MSN / VS180CRL<br>€5.086,00   | MSM / VS180CRL<br>€5.086,00 |  | MMN / VP180CRL<br>€5.086,00                                       | MMM / VP180CRL<br>€5.086,00 |  |
|   | 300X100X72H<br>Mc.<br>Kg.       | MSN / VS200CRL<br>€5.209,00   | MSM / VS200CRL<br>€5.209,00 |  | MMN / VP200CRL<br>€5.209,00                                       | MMM / VP200CRL<br>€5.209,00 |  |
|   | 320X100X72H<br>Mc.<br>Kg.       | MSN / VS220CRL<br>€5.326,00   | MSM / VS220CRL<br>€5.326,00 |  | MMN / VP220CRL<br>€5.326,00                                       | MMM / VP220CRL<br>€5.326,00 |  |
|   |                                 |   |                             |  |   |                             |  |
|   | COLLI packages<br>N°3           | Scrivania con finiture in cuoio e top in vetro temp. predisposta al montaggio del mobile servizio in legno utilizz. a dx e a sx<br><i>Writing desk with leather linings and tempered glass top drew up in advance for assembly of credenza usable on left or right side</i>                   |                             |  |   |                             |  |
|   | 180X220X72H<br>Mc.<br>Kg.       | MSN / VS180P<br>€2.328,00   | MSM / VS180P<br>€2.328,00   |  | MMN / VP180P<br>€2.519,00   | MMM / VP180P<br>€0,00       |  |
|   | 200X220X72H<br>Mc.<br>Kg.       | MSN / VS200P<br>€2.451,00   | MSM / VS200P<br>€2.451,00   |  | MMN / VP200P<br>€2.667,00   | MMM / VP200P<br>€0,00       |  |
|   | 220X220X72H<br>Mc.<br>Kg.       | MSN / VS220P<br>€2.568,00   | MSM / VS220P<br>€2.568,00   |  | MMN / VP220P<br>€2.806,00   | MMM / VP220P<br>€0,00       |  |
|   | COLLI packages<br>N°5           | Scriv. con schienale rivestito in cuoio e top vetro temperato predisposta al montaggio mobile servizio utilizz. a dx e a sx<br><i>Writing desk with straight modesty panel and tempered glass top drew up in advance for assembly of credenza usable on left or right side</i>                |                             |  |   |                             |  |
|   | 180X220X72H<br>Mc.<br>Kg.       | MSN / VS180PL<br>€3.079,00  | MSM / VS180PL<br>€3.079,00  |  | MMN / VP180PL<br>€3.270,00  | MMM / VP180PL<br>€0,00      |  |
|   | 200X220X72H<br>Mc.<br>Kg.       | MSN / VS200PL<br>€3.202,00  | MSM / VS200PL<br>€3.202,00  |  | MMN / VP200PL<br>€3.417,00  | MMM / VP200PL<br>€0,00      |  |
|   | 220X220X72H<br>Mc.<br>Kg.       | MSN / VS220PL<br>€3.319,00  | MSM / VS220PL<br>€3.319,00  |  | MMN / VP220PL<br>€3.557,00  | MMM / VP220PL<br>€0,00      |  |

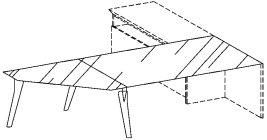
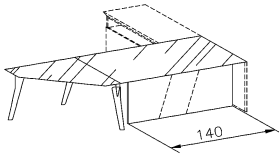
**MASTER LINE - V2.0**

| ALLUNGHI CON TOP VETRO<br>EXTENSIONS WITH GLASS TOP                                |                                 |  |                              |  |   |                              |  |
|--|---------------------------------|--|------------------------------|--|---|------------------------------|--|
| DISEGNO<br>DRAWING   | DIMENSIONI<br>DIMENSIONS<br>Cm. | TOP VETRO SATINATO VS67<br>SATINED GLASS TOP VS67  |                              |  | TOP VETRO LACCATO MOKA VM71<br>LACQUERED MOKA GLASS TOP MOKA VM71 |                              |  |
|  |                                 | CUOIO FINITURE GAMBE<br>LEGS FINISHES THICK LEATHER  |                              |  | CUOIO FINITURE GAMBE<br>LEGS FINISHES THICK LEATHER               |                              |  |
|  | PACKING LIST                    | NATURALE<br>NATURAL<br>CB76  | MOKA<br>MOKA<br>CM81         |  | NATURALE<br>NATURAL<br>CB76                                       | MOKA<br>MOKA<br>CM81         |  |
|    | COLLI packages<br>N°5           | Scrivania con top in vetro temp. predisposta al montaggio del mobile servizio in legno più penisola di convers. utilizz. a dx e a sx<br><i>Writing desk with tempered glass top drew up in advance for assembly of credenza usable on left or right side</i>   |                              |  |   |                              |  |
|  | 280X220X72H<br>Mc.<br>Kg.       | MSN / VS180PCR<br>€3.972,00  | MSM / VS180PCR<br>€3.972,00  |  | MMN / VP180PCR<br>€4.163,00                                       | MMM / VP180PCR<br>€4.163,00  |  |
|  | 300X100X72H<br>Mc.<br>Kg.       | MSN / VS200PCRL<br>€4.095,00   | MSM / VS200PCR<br>€4.095,00  |  | MMN / VP200PCR<br>€4.310,00                                       | MMM / VP200PCR<br>€4.310,00  |  |
|  | 320X100X72H<br>Mc.<br>Kg.       | MSN / VS220PCR<br>€4.213,00  | MSM / VS220PCR<br>€4.213,00  |  | MMN / VP220PCR<br>€4.450,00                                       | MMM / VP220PCR<br>€4.450,00  |  |
|    | COLLI packages<br>N°7           | Scriv. con schie. rivestito in cuoio con top in vetro temp. predisp. al montaggio mobile servizio più penisola di convers. utilizz. a dx e a sx<br><i>Writing desk with modesty panel covered by leather and tempered glass top drew up in advance for assembly of credenza usable on left or right side</i> |                              |  |   |                              |  |
|  | 280X220X72H<br>Mc.<br>Kg.       | MSN / VS180PCRL<br>€4.723,00   | MSM / VS180PCRL<br>€4.723,00 |  | MMN / VP180PCRL<br>€4.914,00                                      | MMM / VP180PCRL<br>€4.914,00 |  |
|  | 300X100X72H<br>Mc.<br>Kg.       | MSN / VS200PCRL<br>€4.846,00   | MSM / VS200PCRL<br>€4.846,00 |  | MMN / VP200PCRL<br>€5.061,00                                      | MMM / VP200PCRL<br>€5.061,00 |  |
|  | 320X100X72H<br>Mc.<br>Kg.       | MSN / VS220PCRL<br>€4.964,00   | MSM / VS220PCRL<br>€4.964,00 |  | MMN / VP220PCRL<br>€5.202,00                                      | MMM / VP220PCRL<br>€5.202,00 |  |
| DISEGNO<br>DRAWING   | DIMENSIONI<br>DIMENSIONS<br>Cm. | STRUTTURA MELAMINICA ALLUMINIO MM21<br>ALUMINIUM MELAMINE STRUCTURE MM21   |                              |  | STRUTTURA MELAMINICA NERO ME28<br>BLACK ME28 MELAMINE STRUCTURE   |                              |  |
|  |                                 | TOP E SCHIENALI LEGNO<br>WOOD TOPS AND MODESTY PANELS  |                              |  |   |                              |  |
|  | PACKING LIST                    | CILIEGIO<br>CHERRY<br>MC04   | WENGE'<br>WENGE'<br>SW06     |  | CILIEGIO<br>CHERRY<br>MC04  | WENGE'<br>WENGE'<br>SW06     |  |
|  | DIMENSIONI<br>DIMENSIONS<br>Cm. | ANTA LEGNO CILIEGIO MC04<br>CHERRY MC04 WOOD DOOR  |                              |  | ANTA LEGNO WENGE' SW06<br>WENGE' SW06 WOOD DOOR                   |                              |  |
|  |                                 | CUOIO MANIGLIE<br>HANDLES THICK LEATHER  |                              |  | CUOIO MANIGLIE<br>HANDLES THICK LEATHER                           |                              |  |
|  | PACKING LIST                    | NATURALE<br>NATURAL<br>CB76  | MOKA<br>MOKA<br>CM81         |  | NATURALE<br>NATURAL<br>CB76                                       | MOKA<br>MOKA<br>CM81         |  |
|  |                                 |  |                              |  |   |                              |  |
|  |                                 |  |                              |  |   |                              |  |
|  |                                 |  |                              |  |   |                              |  |
|  |                                 |  |                              |  |   |                              |  |



**MASTER LINE - V2.0**

| ALLUNGHI CON TOP VETRO<br>EXTENSIONS WITH GLASS TOP |                                 |   |                                 |  |  |                                 |  |
|---|---------------------------------|---|---------------------------------|--|--|---------------------------------|--|
| DISEGNO<br>DRAWING                                  | DIMENSIONI<br>DIMENSIONS<br>Cm. | TOP VETRO SATINATO VS67<br>SATINED GLASS TOP VS67   |                                 |  | TOP VETRO LACCATO MOKA VM71<br>LACQUERED MOKA GLASS TOP MOKA VM71                            |                                 |  |
|   |                                 | CUOIO FINITURE GAMBE<br>LEGS FINISHES THICK LEATHER   |                                 |  | CUOIO FINITURE GAMBE<br>LEGS FINISHES THICK LEATHER  |                                 |  |
|   | PACKING LIST                    | NATURALE<br>NATURAL<br>CB76   | MOKA<br>MOKA<br>CM81            |  | NATURALE<br>NATURAL<br>CB76  | MOKA<br>MOKA<br>CM81            |  |
|   | COLLI packages<br>N°3           | Allungo registrabile autonomo dalla scrivania con top rettangolare in vetro temperato<br><i>Adjustable independent extension with rectangular tempered glass top.</i>   |                                 |  |  |                                 |  |
|   | 120X60X72H<br>Mc.<br>Kg.        | MSN / VS120REA<br>€1.601,00   | MSM / VS120REA<br>€1.601,00     |  | MMN / VP120REA<br>€1.732,00  | MMM / VP120REA<br>€1.732,00     |  |
|   |                                 |   |                                 |  |  |                                 |  |
|   | DIMENSIONI<br>DIMENSIONS<br>Cm. | INDICARE IL COLORE STRUTTURA CAMBIANDO LA LETTERA "?" CON : A = ALLUMINIO; E = NERO<br><i>INDICATE THE COLOR OF THE STRUCTURE CHANGING LETTER "?" WITH : ?A = ALUMINIUM; ?E = BLACK</i>   |                                 |  |  |                                 |  |
|   |                                 | TOP VETRO SATINATO VS67 FRONTALI CILIEGIO MC04<br>SATINED GLASS VS67 TOP CHERRY MC04 FRONTAL  |                                 |  | TOP VETRO MOKA VM71 FRONTALI CILIEGIO MC04<br>MOKA GLASS VM71 TOP CHERRY MC04 FRONTAL PANELS |                                 |  |
|   |                                 | LEGS FINISHES AND HANDLES THICK LEATHER<br>LEGS FINISHES AND HANDLES THICK LEATHER  |                                 |  | CUOIO FINITURE GAMBE E MANIGLIE<br>LEGS FINISHES AND HANDLES THICK LEATHER                   |                                 |  |
|   | PACKING LIST                    | NATURALE<br>NATURAL<br>CB76   | MOKA<br>MOKA<br>CM81            |  | NATURALE<br>NATURAL<br>CB76  | MOKA<br>MOKA<br>CM81            |  |
|   | COLLI packages<br>N°3           | Allungo registrabile autonomo dalla scrivania con top rettangolare in vetro temperato e cassetteria a 3 cassetti legno CILIEGIO<br><i>Adjustable extension independent from the writing desk having rectangular tempered glass top and 3 drawers unit on cherry wood</i>            |                                 |  |  |                                 |  |
|   | 120X60X72H<br>Mc.<br>Kg.        | M?SCN / VS120RE31A<br>€2.557,00   | M?SCM / VS120RE31A<br>€2.557,00 |  | M?MCN / VP120RE31A<br>€2.687,00  | M?MCM / VP120RE31A<br>€2.687,00 |  |
|   |                                 |   |                                 |  |  |                                 |  |
|   | COLLI packages<br>N°3           | Allungo registr. autonomo dalla scrivania con top rettangolare in vetro temperato e cassetteria a 1 cassetto più sched. legno CILIEGIO<br><i>Adjustable extension independent from the writing desk having rectangular tempered glass top and filing drawer unit on cherry wood</i> |                                 |  |  |                                 |  |
|   | 120X60X72H<br>Mc.<br>Kg.        | M?SCN / VS120RE33A<br>€2.499,00   | M?SCM / VS120RE33A<br>€2.499,00 |  | M?MCN / VP120RE33A<br>€2.629,00  | M?MCM / VP120RE33A<br>€2.629,00 |  |
|   |                                 |   |                                 |  |  |                                 |  |
|   | DIMENSIONI<br>DIMENSIONS<br>Cm. | INDICARE IL COLORE STRUTTURA CAMBIANDO LA LETTERA "?" CON : A = ALLUMINIO; E = NERO<br><i>INDICATE THE COLOR OF THE STRUCTURE CHANGING LETTER "?" WITH : A = ALUMINIUM; E = BLACK</i>   |                                 |  |  |                                 |  |
|   |                                 | TOP VETRO SATINATO VS67 FRONTALI WENGE' SW06<br>SATINED GLASS VS67 TOP WENGE' SW06 FRONTAL  |                                 |  | TOP VETRO MOKA VM71 FRONTALI WENGE' SW06<br>MOKA GLASS VM71 TOP WENGE' SW06 FRONTAL PANELS   |                                 |  |
|   |                                 | LEGS FINISHES AND HANDLES THICK LEATHER<br>LEGS FINISHES AND HANDLES THICK LEATHER  |                                 |  | CUOIO FINITURE GAMBE E MANIGLIE<br>LEGS FINISHES AND HANDLES THICK LEATHER                   |                                 |  |
|   | PACKING LIST                    | NATURALE<br>NATURAL<br>CB76   | MOKA<br>MOKA<br>CM81            |  | NATURALE<br>NATURAL<br>CB76  | MOKA<br>MOKA<br>CM81            |  |
|   | COLLI packages<br>N°3           | Allungo registrabile autonomo dalla scrivania con top rettangolare in vetro temperato e cassetteria a 3 cassetti legno WENGE'<br><i>Adjustable extension independent from the writing desk having rectangular tempered glass top and 3 drawers unit on WENGE' wood</i>              |                                 |  |  |                                 |  |
|   | 120X60X72H<br>Mc.<br>Kg.        | M?SQN / VS120RE31A<br>€2.557,00   | M?SQM / VS120RE31A<br>€2.557,00 |  | M?MQN / VP120RE31A<br>€2.687,00  | M?MQM / VP120RE31A<br>€2.687,00 |  |
|   |                                 |   |                                 |  |  |                                 |  |
|   | COLLI packages<br>N°3           | Allungo registr. autonomo dalla scrivania con top rettangolare in vetro temperato e cassetteria a 1 cassetto più sched. legno WENGE'<br><i>Adjustable extension independent from the writing desk having rectangular tempered glass top and filing drawer unit on WENGE' wood</i>   |                                 |  |  |                                 |  |
|   | 120X60X72H<br>Mc.<br>Kg.        | M?SQN / VS120RE33A<br>€2.499,00   | M?SQM / VS120RE33A<br>€2.499,00 |  | M?MQN / VP120RE33A<br>€2.629,00  | M?MQM / VP120RE33A<br>€2.629,00 |  |
|   |                                 |   |                                 |  |  |                                 |  |

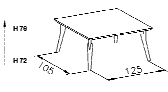
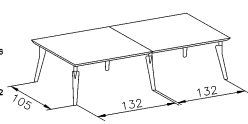
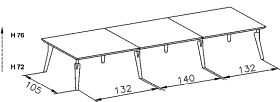
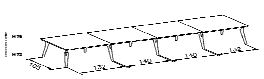
MASTER LINE - V2.0

| TAVOLI CON TOP LEGNO<br>TABLES WITH WOOD TOP                                       |                                 |  |                          |  |  |                          |  |
|--|---------------------------------|--|--------------------------|--|--|--------------------------|--|
| DISEGNO<br>DRAWING   | DIMENSIONI<br>DIMENSIONS<br>Cm. | TOP LEGNO CILIEGIO MC04<br>CHERRY MC04 WOODEN TOP  |                          |  | TOP LEGNO WENGE' SW06<br>WENGE' SW06 WOODEN TOP  |                          |  |
|  |                                 | CUOIO FINITURE GAMBE<br>LEATHER FINISHES FOR LEG   |                          |  | CUOIO FINITURE GAMBE<br>LEATHER FINISHES FOR LEG |                          |  |
|  | PACKING LIST                    | NATURALE<br>NATURAL<br>CB76  | MOKA<br>MOKA<br>CM81     |  | NATURALE<br>NATURAL<br>CB76                      | MOKA<br>MOKA<br>CM81     |  |
|   | COLLI packages<br>N°3           | Tavolo riunione componibile avente 4 gambe regolabili e top rettangolare in legno da 6 posti<br><i>Modular meeting table with 4 adjustable legs and rectangular wooden top for 6 seats</i>   |                          |  |  |                          |  |
|  | 140X120X72H<br>Mc.<br>Kg.       | MCN / 140TC<br>€2.312,00   | MCM / 140TC<br>€2.312,00 |  | MQN / 140TC<br>€2.312,00                         | MQM / 140TC<br>€2.312,00 |  |
|  |                                 |  |                          |  |  |                          |  |
|    | COLLI packages<br>N°6           | Tavolo riunione componibile avente 6 gambe regolabili e top rettangolare in legno da 10 posti, <b>senza giunzioni cuoio</b><br><i>Modular meeting table with 6 adjustable legs and rectangular wooden top for 10 seats without leather junctions</i>   |                          |  |  |                          |  |
|  | 280X120X72H<br>Mc.<br>Kg.       | MCN / 280TC<br>€3.045,00   | MCM / 280TC<br>€3.045,00 |  | MQN / 280TC<br>€3.045,00                         | MQM / 280TC<br>€3.045,00 |  |
|  |                                 |  |                          |  |  |                          |  |
|   | COLLI packages<br>N°9           | Tavolo riunione componibile avente 8 gambe regolabili e top rettangolare in legno da 14 posti, <b>senza giunzioni cuoio</b><br><i>Modular meeting table with 8 adjustable legs and rectangular wooden top for 14 seats without leather junctions</i>   |                          |  |  |                          |  |
|  | 420X120X72H<br>Mc.<br>Kg.       | MCN / 420TC<br>€4.284,00   | MCM / 420TC<br>€4.284,00 |  | MQN / 420TC<br>€4.284,00                         | MQM / 420TC<br>€4.284,00 |  |
|  |                                 |  |                          |  |  |                          |  |
|  | COLLI packages<br>N°12          | Tavolo riunione componibile avente 10 gambe regolabili e top rettangolare in legno da 18 posti, <b>senza giunzioni cuoio</b><br><i>Modular meeting table with 10 adjustable legs and rectangular wooden top for 18 seats without leather junctions</i> |                          |  |  |                          |  |
|  | 560X120X72H<br>Mc.<br>Kg.       | MCN / 560TC<br>€5.522,00   | MCM / 560TC<br>€5.522,00 |  | MQN / 560TC<br>€5.522,00                         | MQM / 560TC<br>€5.522,00 |  |
|  |                                 |  |                          |  |  |                          |  |
|  |                                 |  |                          |  |  |                          |  |
|  |                                 |  |                          |  |  |                          |  |
|  |                                 |  |                          |  |  |                          |  |
|  |                                 |  |                          |  |  |                          |  |

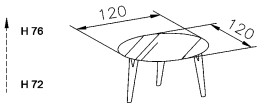
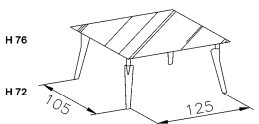
MASTER LINE - V2.0

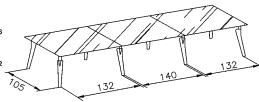
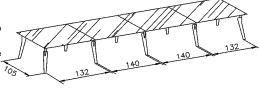
| TAVOLI CON TOP VETRO<br>TABLES WITH GLASS TOP                                      |                                |  |                             |  |   |                            |  |
|--|--------------------------------|--|-----------------------------|--|---|----------------------------|--|
| DISEGNO<br>DRAWING   | DIMENSION<br>DIMENSIONS<br>Cm. | TOP VETRO SATINATO VS67<br>SATINED GLASS TOP VS67  |                             |  | TOP VETRO LACCATO MOKA VM71<br>LACQUERED MOKA GLASS TOP MOKA VM71 |                            |  |
|  |                                | CUOIO FINITURE GAMBE<br>LEATHER FINISHES FOR LEG   |                             |  | CUOIO FINITURE GAMBE<br>LEATHER FINISHES FOR LEG                  |                            |  |
|  | PACKING<br>LIST                | NATURALE<br>NATURAL<br>CB76  | MOKA<br>MOKA<br>CM81        |  | NATURALE<br>NATURAL<br>CB76                                       | MOKA<br>MOKA<br>CM81       |  |
|    | COLLI packages<br>N°6          | Tavolo riunione avente 4 gambe regolabili e top rotondo in vetro temperato da 6 posti<br><i>Modular meeting table with 4 adjustable legs and round glass top for 6 seats</i>   |                             |  |   |                            |  |
|  | 140X140X72H<br>Mc.<br>Kg.      | MSN / VS120TAR<br>€2.377,00  | MSM / VP120TAR<br>€2.377,00 |  |   |                            |  |
|   | COLLI packages<br>N°6          | Tavolo riunione componibile avente 4 gambe regolabili e top rettangolare in vetro temperato da 6 posti<br><i>Modular meeting table with 4 adjustable legs and rectangular glass top for 6 seats</i>  |                             |  |   |                            |  |
|  | 140X120X72H<br>Mc.<br>Kg.      | MSN / VS140TC<br>€2.787,00   | MSM / VS140TC<br>€2.787,00  |  | MMN / VP140TC<br>€2.979,00  | MMM / VP140TC<br>€2.979,00 |  |
|  | COLLI packages<br>N°6          | Tavolo riunione componibile avente 6 gambe regolabili e top rettangolare in vetro temperato da 10 posti, <b>senza giunzioni cuoio</b><br><i>Modular meeting table with 6 adjustable legs and rectangular glass top for 10 seats, without leather junctions</i>   |                             |  |   |                            |  |
|  | 280X120X72H<br>Mc.<br>Kg.      | MSN / VS280TC<br>€4.291,00   | MSM / VS280TC<br>€4.291,00  |  | MMN / VT280TC<br>€4.674,00  | MMM / VT280TC<br>€4.674,00 |  |
|  | COLLI packages<br>N°9          | Tavolo riunione componibile avente 8 gambe regolabili e top rettangolare in vetro temperato da 14 posti, <b>senza giunzioni cuoio</b><br><i>Modular meeting table with 8 adjustable legs and rectangular glass top for 14 seats, without leather junctions</i>   |                             |  |   |                            |  |
|  | 420X120X72H<br>Mc.<br>Kg.      | MSN / VS420TC<br>€6.356,00   | MSM / VS420TC<br>€6.356,00  |  | MMN / VP420TC<br>€6.930,00  | MMM / VP420TC<br>€6.930,00 |  |
|  | COLLI packages<br>N°12         | Tavolo riunione componibile avente 10 gambe regolabili e top rettangolare in vetro temperato da 18 posti, <b>senza giunzioni cuoio</b><br><i>Modular meeting table with 10 adjustable legs and rectangular glass top for 18 seats, without leather junctions</i> |                             |  |   |                            |  |
|  | 560X120X72H<br>Mc.<br>Kg.      | MSN / VS560TC<br>€8.422,00   | MSM / VS560TC<br>€8.422,00  |  | MMN / VP560TC<br>€9.188,00  | MMM / VP560TC<br>€9.188,00 |  |

MASTER LINE - V2.0

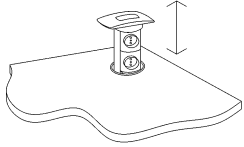
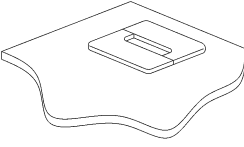
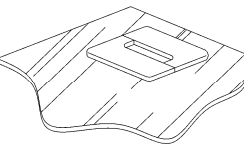
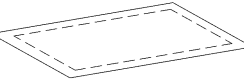
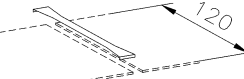
| COMPLEMENTI TAVOLI RIUNIONE<br>COMPLEMENTS FOR MEETING TABLES                      |                                 |   |                      |  |                                |  |  |
|--|---------------------------------|---|----------------------|--|--------------------------------|--|--|
| DISEGNO<br>DRAWING   | DIMENSIONI<br>DIMENSIONS<br>Cm. |   |                      |  |                                |  |  |
|  | PACKING LIST                    | NATURALE<br>NATURAL<br>CB76   | MOKA<br>MOKA<br>CM81 |  | ALLUMINIO<br>ALUMINIUM<br>EM41 |  |  |
|    | COLLI packages<br>N° 1          | Portapresa a scomparsa con due prese schuko e due di colleg. rete ( indicare la posizione sul piano dove deve essere applicata )<br>Socket box containing two schuko sockets and two Ethernet sockets (the position of application must be indicated on the tops)                 |                      |  |                                |  |  |
|  | Mc.                             |   |                      |  | OA / PPR4                      |  |  |
|  | Kg.                             |   |                      |  | €269,00                        |  |  |
|    | COLLI packages<br>N° 1          | Passacavo rettangolare con foro Ø 80 per tavoli legno, cuoio, HPL ( indicare la posizione sul piano dove deve essere applicato )<br>Rectangular socket box with an 80 mm hole to be used on wood, leather or hpl tops (the position of application must be indicated on the tops) |                      |  |                                |  |  |
|  | Mc.                             | MN / PCA1   | MM / PCA1            |  |                                |  |  |
|  | Kg.                             | €51,00  | €51,00               |  |                                |  |  |
|   | COLLI packages<br>N° 1          | Passacavo rettangolare satinato con foro Ø 80 per tavoli vetro ( indicare la posizione sul piano dove deve essere applicato )<br>Satin rectangular socket box with an 80 mm hole to be used on glass tops (the position of application must be indicated on the tops)             |                      |  |                                |  |  |
|  | Mc.                             | MN / PCA1VP   | MM / PCA1VP          |  |                                |  |  |
|  | Kg.                             | €51,00  | €51,00               |  |                                |  |  |
|  |                                 |   |                      |  |                                |  |  |
|  |                                 |   |                      |  |                                |  |  |
| DISEGNO<br>DRAWING   |                                 |   |                      |  |                                |  |  |
|  |                                 | RIVESTIMENTI CUIO<br>LEATHER LININGS  |                      |  |                                |  |  |
|  |                                 | NATURALE<br>NATURAL<br>CB76   | MOKA<br>MOKA<br>CM81 |  |                                |  |  |
|  | COLLI packages<br>N°            | Sottomano per tavoli riunione<br>Desk pad for meeting table   |                      |  |                                |  |  |
|  | 53X35<br>Mc.                    | MN / STA  | MM / STA             |  |                                |  |  |
|  | Kg.                             | €302,00   | €302,00              |  |                                |  |  |
|  | COLLI packages<br>N°            | Giunzioni in cuoio da montare sui tavoli componibili in legno e in vetro in corrispondenza dell'unione di due piani<br>Leather junction to be assembled on modular tables on the tops junction  |                      |  |                                |  |  |
|  | 120X??<br>Mc.                   | MN / 12GIUN   | MM / 12GIUN          |  |                                |  |  |
|  | Kg.                             | €314,00   | €314,00              |  |                                |  |  |

**MASTER LINE - V2.0**

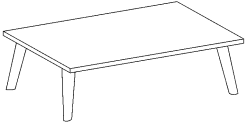
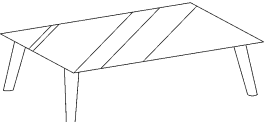
| TAVOLINI ATTESA<br>SIDE TABLES   |                                 |  |                                   |  |  |  |  |
|--|---------------------------------|--|-----------------------------------|--|--|--|--|
| DISEGNO<br>DRAWING   | DIMENSIONI<br>DIMENSIONS<br>Cm. | TOP LEGNO<br>WOODEN TOP  |                                   |  |  |  |  |
|  |                                 |  |                                   |  |  |  |  |
|  | PACKING<br>LIST                 | CILIEGIO<br>CHERRY<br>MC04   | WENGE'<br>WENGE'<br>SW06          |  |  |  |  |
|    | COLLI packages<br>N°2           | Tavolino attesa con top rettangolare in legno<br><i>Holding table with rectangular wooden top</i>          |                                   |  |  |  |  |
|  | 70X70X42H<br>Mc.                | MC / 70TVN   | MQ / 70TVN                        |  |  |  |  |
|  | Kg.                             | €815,00  | €815,00                           |  |  |  |  |
|  | 120X60X42H<br>Mc.               | MC / 120TVN  | MQ / 120TVN                       |  |  |  |  |
| Kg.  | €984,00                         | €984,00  |                                   |  |  |  |  |
|  |                                 |  |                                   |  |  |  |  |
|  |                                 |  |                                   |  |  |  |  |
|  |                                 |  |                                   |  |  |  |  |
|  |                                 |  |                                   |  |  |  |  |
| DISEGNO<br>DRAWING   | DIMENSIONI<br>DIMENSIONS<br>Cm. | TOP VETRO<br>GLASS TOP   |                                   |  |  |  |  |
|  |                                 |  |                                   |  |  |  |  |
|  | PACKING<br>LIST                 | SATINATO<br>SATIN<br>VS67  | LACCATO MOKA<br>LACQUERED<br>VM71 |  |  |  |  |
|  | COLLI packages<br>N°2           | Tavolino attesa con top rettangolare in vetro temperato<br><i>Holding table with rectangular glass top</i> |                                   |  |  |  |  |
|  | 70X70X42H<br>Mc.                | MS / VS70TVN   | MM / VP70TVN                      |  |  |  |  |
|  | Kg.                             | €1.078,00  | €1.078,00                         |  |  |  |  |
|  | 120X60X42H<br>Mc.               | MS / VS120TVN  | MM / VP120TVN                     |  |  |  |  |
| Kg.  | €1.218,00                       | €1.218,00  |                                   |  |  |  |  |
|  |                                 |  |                                   |  |  |  |  |
|  |                                 |  |                                   |  |  |  |  |
|  |                                 |  |                                   |  |  |  |  |
|  |                                 |  |                                   |  |  |  |  |

**note**